

# **Automatic Outdoor Ice Maker**

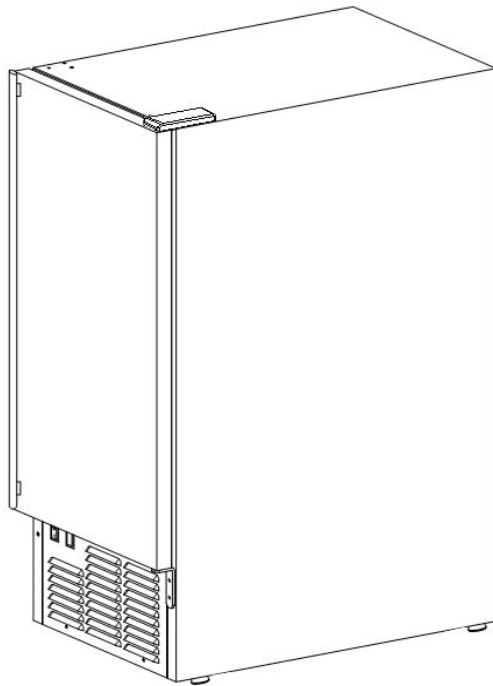

## **User's Manual**

***Be sure unit is standing upright 24 hours prior to plug-in***

**Model: BBQ10700**

# Table of Contents

	<b>Page</b>
ICE MAKER SAFETY.....	2
IMPORTANT SAFEGUARDS.....	3 - 5
TECHNICAL INFORMATION .....	5
INTRODUCTION .....	6
COMPONENT LOCATIONS .....	7
ICEMAKER INSTALLATION .....	8 - 15
Unpacking.....	8
Location Requirements.....	8 - 9
Electrical Requirements.....	10
Leveling the Ice Maker.....	11
Reversing the Door Swing.....	11 – 12
Water Supply.....	12 – 13
Drain .....	13
Installation Types .....	14
OPERATION .....	15 - 18
Final Checklist before Operation.....	15
Operating Method.....	15 - 16
How the Machine Makes Ice .....	16
How the Machine Uses the Water.....	17
Normal Sounds.....	18
Preparing the Ice Maker for Long Storage .....	18
CLEANING AND MAINTENANCE .....	19 - 22
Exterior Cleaning.....	19
Interior Cleaning.....	20
Condenser Cleaning.....	20-21
Water Distribution Tube Cleaning .....	21
Ice-Making System Cleaning.....	21 - 22
MAJOR FUNCTIONS .....	23
TROUBLESHOOTING.....	24 - 25

**We reserve the right to make changes in specifications and design without prior notice.**

# Ice Maker Safety

*Your safety and the safety of others are very important.*

We have provided many important safety messages in this manual and on your appliance. Always read and obey all safety messages.



This is the Safety Alert Symbol. This symbol alerts you to potential hazards that can injure or kill you and others. All safety messages will follow the Safety Alert Symbol and either the words "**DANGER**", "**WARNING**" OR "**CAUTION**".



DANGER means that failure to heed this safety statement may result in severe personal injury or death.



WARNING means that failure to heed this safety statement may result in extensive product damage, serious personal injury or death.



CAUTION means that failure to heed this safety statement may result in minor or moderate personal injury, or property or equipment damage.

All safety messages will alert you to what the potential hazard is, tell you how to reduce the chance of injury, and let you know what can happen if the instructions are not followed.

## **IMPORTANT SAFETY INSTRUCTIONS**

**WARNING: To reduce the risk of fire, electric shock or injury when using your ice maker, follow these basic precautions:**

- *Plug into grounded 3-prong outlet.*
- *Do not remove grounding prong.*
- *Do not use an adapter.*
- *Do not use an extension cord.*
- *Disconnect power before cleaning.*
- *Disconnect power before servicing.*
- *Replace all panels before operating.*
- *Use 2 or more people to move & install ice*

**SAVE THESE INSTRUCTION**

# IMPORTANT SAFEGUARDS



Before the ice maker is used, it must be properly positioned and installed as described in this manual, so read the manual carefully. Jackson Grills strongly recommends that you have a professional install your new machine. The warranty may be affected or voided by an incorrect installation. To reduce the risk of fire, electrical shock or injury when using the ice maker, follow basic precautions, including the following:

## DANGER

- Plug into a grounded 3-prong outlet. Do not remove grounding prong, do not use adapter, and do not use an extension cord.
- It is recommended that a separate circuit, serving only your ice maker, be provided. Use receptacles that cannot be turned off by a switch or pull chain.
- Do not connect or disconnect the electric plug when your hands are wet.
- Never unplug the icemaker by pulling on the power cord. Always grip the plug firmly and pull straight out from the outlet.
- Never clean ice maker parts with flammable fluids. Do not store or use gasoline or other flammable vapors and liquids in the vicinity of this or any other appliance. The fumes can create a fire hazard or explosion.
- Before proceeding with cleaning and maintenance operations, make sure the power line of the unit is disconnected and the water line is shut off. (EXCEPTION: When cleaning the machine's ice making and water systems - See pages 21-22)
- Before operating, put all panels back into place.
- Never allow children to operate, play with or crawl inside the ice maker.
- Do not touch the evaporator by hand when the machine is operating.
- Unplug the ice maker or disconnect power before cleaning or servicing. Failure to do so can result in electrical shock or death.
- Do not attempt to repair or replace any part of your ice maker unless it is specifically recommended in this manual. All other servicing should be referred to a qualified technician.

## **WARNING**

- Use two or more people to move and install ice maker. Failure to do so can result in back or other injury.
- To ensure proper ventilation for your ice maker, the front of the unit must be completely unobstructed. Choose a well-ventilated area with temperatures above 45°F (7°C) and below 110° F (43°C).
- The ice maker should not be located next to ovens, grills or other sources of high heat.
- The ice maker must be installed with all electrical and water connections in accordance with state and local codes. A standard electrical supply (115VAC, 60Hz, 15A), properly grounded in accordance with the National Electrical Code and local codes and ordinances is required.
- Do not kink or pinch the power supply cord between the ice maker and cabinet.
- The fuse (or circuit breaker) size should be 15 amperes.
- It is important for the ice maker to be leveled in order to work properly. You may need to make several adjustments to level it.
- All installations must be in accordance with local plumbing code requirements.
- Make certain that the hoses are not pinched or kinked or damaged during installation.
- Check for leaks after connection.
- Although the unit has been tested at the factory, due to long-term transit and storage, the first batch of cubes must be discarded.
- Remove the packing materials and clean the ice maker before using.
- Turn on the water supply tap before switching on the ice maker. Never turn the water supply tap off when the ice maker is working.
- Except to take ice from the unit, keep the door closed in order to reduce ice melting and to promote proper ice formation.
- If the ice maker will not be used for a long time, before the next use it must be thoroughly cleaned. Follow carefully any instructions provided for cleaning or use of sanitizing solution. Do not leave any solution inside the ice maker after cleaning.
- DO NOT touch the condenser fins. The condenser fins are sharp and can be easily damaged.
- DO NOT use solvent-based cleaning agents or abrasives on the interior. These cleaners may transmit taste to the ice cubes, or damage or discolor the interior.
- The ice machine cleaner contains acids. DO NOT use or mix with any other solvent-based cleaner products. Use rubber gloves to protect hand. Carefully read the material safety instructions on the container of the ice machine cleaner.
- Do not use this apparatus for other than its intended purpose.

## SAVE THESE INSTRUCTIONS

### Electrical Connection

Do not, under any circumstances, cut or remove the third (ground) prong from the power cord. For personal safety, this appliance must be properly grounded. The power cord of this appliance is equipped with a 3-prong grounding plug that mates with a standard 3-prong grounding wall outlet to minimize the possibility of electric shock hazard from the appliance. Have the wall outlet and circuit checked by a qualified electrician to make sure the outlet is properly grounded. When a standard 2-prong wall outlet is encountered, it is your responsibility and obligation to have it replaced with a properly grounded 3-prong wall outlet. The ice maker should always be plugged into its own individual electrical outlet which has a voltage rating that matches the rating label on the appliance. This provides the best performance and also prevents overloading house wiring circuits which could cause a fire hazard from overheated wires. Never unplug your ice maker by pulling on the power cord. Always grip the plug firmly and pull straight out from the outlet. Repair or replace immediately all power cords that have become frayed or otherwise damaged. Do not use a cord that shows cracks or abrasion damage along its length or at either end. When moving the ice maker, be careful not to damage the power cord.

### Extension Cord

Because of potential safety hazards under certain conditions, it is strongly recommended that you do not use an extension cord with this ice maker.

## Technical Information

<b>Model:</b>	BBQ10700
<b>Electrical power:</b>	115VAC ~ 60Hz
<b>Power consumption:</b>	13.2kWh/100 lbs of ice
<b>Ice-making/Ice-harvest rated current:</b>	3.7A/4.8A
<b>Refrigerant:</b>	R134a, 7.06 oz.
<b>High/Low Side Pressure:</b>	350psig/130psig
<b>Width × Depth × Height (with feet):</b>	14.6"×23.6"×33.5"
<b>Unit weight:</b>	88 lbs
<b>Ice-making capacity:</b>	44 lbs/day*
<b>Max. ice storage:</b>	25 lbs
<b>Ice shape:</b>	Cube
<b>Ice cube dimensions:</b>	$\frac{3}{4}" \times \frac{3}{4}" \times 1"$

The technical data and performance index listed above should be used for reference only. They are subject to change.

\* The actual quantity of ice produced per day can vary with room and water conditions.

# Introduction

The Jackson Grills BBQ10700 Ice Maker produces hard, crystal-clear, gourmet cube ice, and offers convenience for homeowners and hotel guests. It can be used both indoors and outdoors. An insulated, removable ice storage bin is included.

This user's manual is intended as a resource for persons installing, using and servicing model BBQ10700. It contains valuable information on safety and maintenance. Jackson Grills strongly recommends that this manual be kept in a place where it can be accessed when needed.

Every Jackson Grills Ice Maker is designed and manufactured according to the highest standards of safety and performance. It meets or exceeds the safety standard of UL563.

# Component Locations

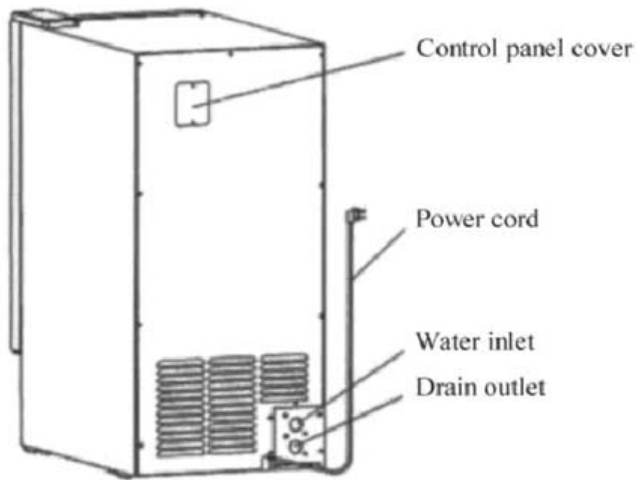
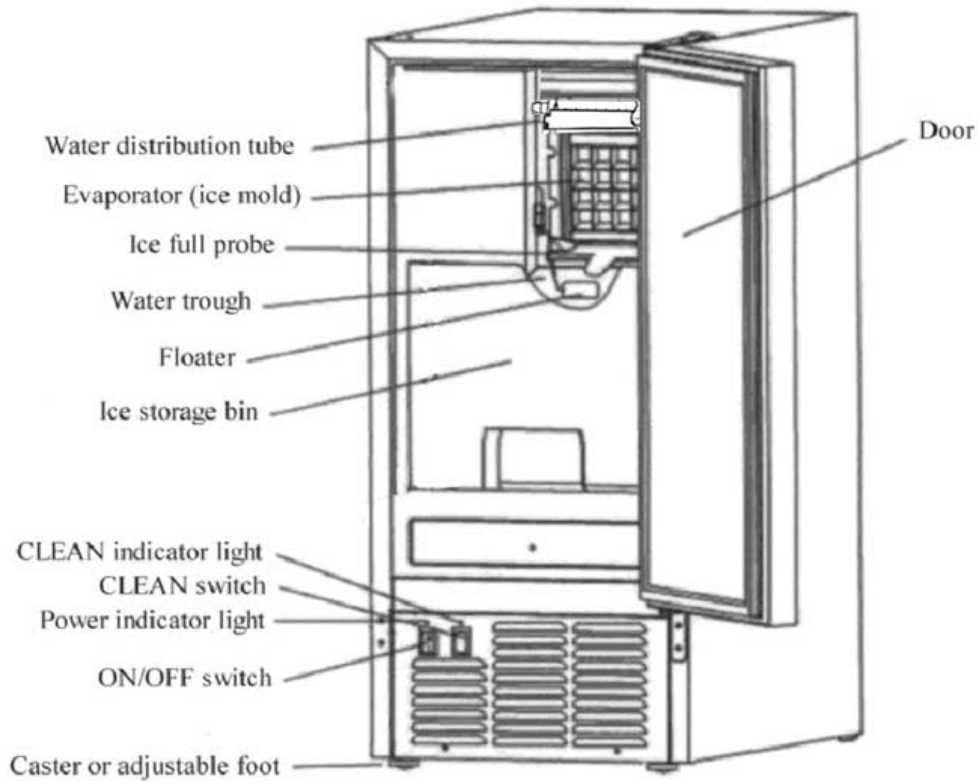

Caster without lock



Caster with lock



Ice scoop



Drain hose



Water supply hose



# Ice Maker Installation

## Unpacking

 **WARNING**

**Excessive Weight Hazard**

Use two or more people to move and install ice maker.  
Failure to do so can result in back or other injury.

## Remove packaging materials

*IMPORTANT: Do not remove any permanent instruction labels or the data label on your ice maker.*

Remove tape and glue from your ice maker before using.

- To remove any remaining tape or glue, rub the area briskly with your thumb. Tape or glue residue can also be easily removed by rubbing a small amount of liquid dish soap over the adhesive with your fingers. Wipe with warm water and dry.
- Do not use sharp instruments, rubbing alcohol, flammable fluids, or abrasive cleaners to remove tape or glue. These products can damage the surface of your ice maker.

## Cleaning before use

After you remove all of the packaging materials, clean the inside of your ice maker before using it. See "Interior cleaning" in the *Cleaning and Maintenance* section.

## Location Requirements

Top View

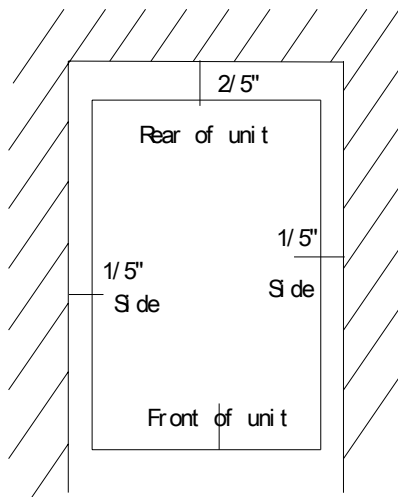

Side View

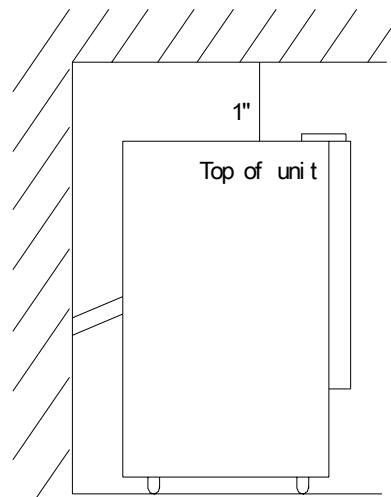

INSTALLATION CLEARANCES



- This ice maker should be installed by qualified personnel.
- To ensure proper ventilation for your ice maker, the front of the unit must be completely unobstructed.
- When installing the ice maker under a counter, follow the recommended spacing dimensions shown on the previous page. Allow 2/5" (10mm) or more clearance at rear, 1/5" (5.1mm) at the sides and 1" (25.4mm) at the top for proper air circulation. The installation should allow the ice maker to be pulled forward for servicing if necessary.
- Choose a well-ventilated area with temperatures above 45°F (7°C) and below 110° F (43°C).
- The unit should not be located next to ovens, grills or other sources of high heat.
- Installation of the ice maker requires a cold water supply inlet of 1/4" (6.35mm) soft copper tubing with a shut-off valve.
- The ice maker requires a continuous water supply with a minimum pressure of 15 psig and a static pressure not to exceed 80 psig. The temperature of the water feeding into the ice maker should be between 41°F (5°C) and 90°F (32°C) for proper operation.

WARNING

Normal operating ambient temperature should be between 45°F (7°C) to 110° F (43°C). Normal operating water temperature should be between 41°F (5°C) and 90°F (32°C). Operation of the ice maker for extended periods outside of these normal temperature ranges may affect production capacity.

- *It is strongly recommended that a water filter be used.* A filter, if it is of the proper type, can remove taste and odors as well as particles. Some water is very hard; softened water may result in white, mushy cubes that stick together. De-ionized water is not recommended.
- The ice maker must be installed with all electrical and water connections in accordance with all state and local codes.
- The unit should be located on a firm and level surface. It is important for the ice maker to be leveled in order to work properly. If needed, you can adjust the height of the ice maker adjustable feet. See the *Leveling the Ice Maker* section.
- A standard electrical supply (115V AC only, 60Hz, 15A), properly grounded in accordance with the National Electrical Code and local codes and ordinances, is required.
- **IMPORTANT:** Do not kink or pinch the power supply cord between the ice maker and wall or cabinet.

## *Electrical Requirements*

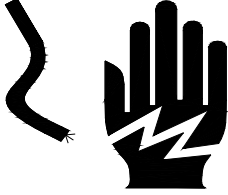
 <b>DANGER</b> 

<b>Electrical Shock Hazard</b> Plug into a grounded 3- prong outlet. Never remove the ground prong from the plug. Never use an adapter. Never use an extension cord. Failure to follow these instructions can result in fire, electrical shock or death.

Before you move your ice maker into its final location, be sure you have the proper electrical connection:

A standard electrical supply (115V AC only, 60Hz, 15A), properly grounded in accordance with the National Electrical Code and local codes and ordinances, is required. The ice maker should always be plugged into its own individual electrical outlet.

It is recommended that a separate circuit, serving only your ice maker, be provided. Use receptacles that cannot be turned off by a switch or pull chain.

The fuse (or circuit breaker) size should be 15 amperes.

### **Recommended grounding method**

For your personal safety, this appliance must be grounded. It is equipped with a power supply cord having a 3-prong grounding plug. To minimize a possible shock hazard, the cord must be plugged into a mating 3-pronged and grounding-type wall receptacle, grounded in accordance with the National Electrical Code and local codes and ordinances. If a mating wall receptacle is not available, it is the personal responsibility of the customer to have a properly grounded, 3-prong wall receptacle installed by a qualified electrician.

## ***Leveling the Ice Maker***

It is important for the ice maker to be leveled in order to work properly; otherwise water will not flow as it should through the evaporator (ice mold). Ice production will be less than normal, and operation will be noisy. The ice maker can be raised or lowered by four leveling legs on the bottom of the machine. If you find that the surface is not level. You may need to make several adjustments to level the machine. We recommend using a carpenter's level to check it.

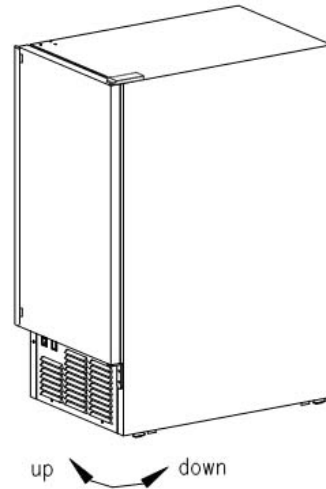

1. Place a carpenter's level on top of the product to see if the ice maker is level from front to back and side to side.
2. Adjust the height of the legs as follows:
  - Turn the leveling legs to the right to lower that side of the ice maker.
  - Turn the leveling legs to the left to raise that side of the ice maker.

***IMPORTANT:*** Once you are ready to install it in a cabinet or directly on the floor, you must adjust the legs to level the ice maker.

## ***Reversing the Door Swing***

**TOOLS NEEDED:** Flat screwdriver, Phillips screwdriver

**IMPORTANT:** Before you begin, unplug the ice maker or disconnect power.

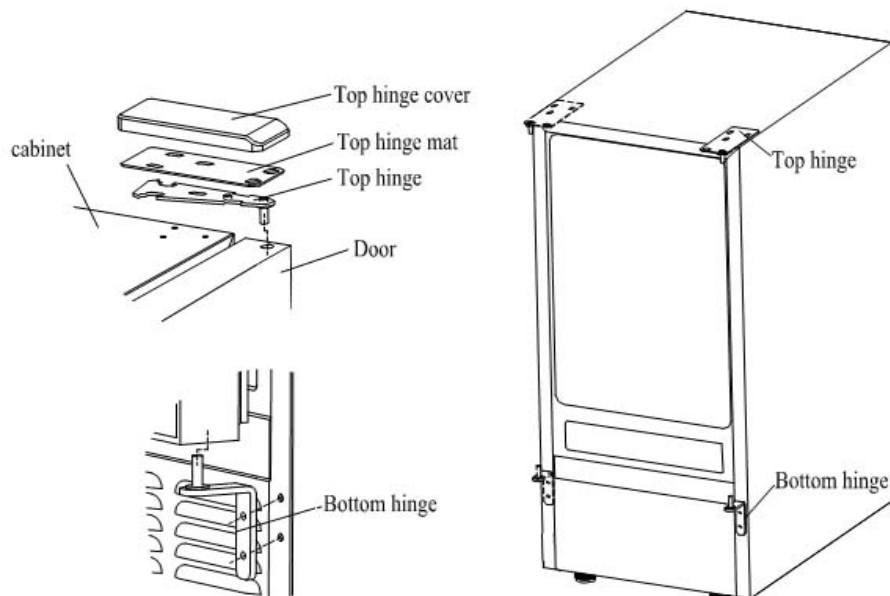

***To remove door from hinges:***

1. Remove the top hinge cover.
2. Using a Phillips screwdriver, remove the screws, then remove top hinge mat and top hinge. Keep the parts together and set them aside.
3. Lift the door off of the bottom hinge and turn it upside down so that the handle is on the right. Set the door aside.

**To replace door on hinges:**

1. Using a flat screwdriver, remove the plug buttons from the screw holes opposite the door hinges, top and bottom. Set aside.
2. Remove the bottom hinge and place it on the opposite side at the bottom of the door.
3. Position the door on the bottom hinge.
4. Align the door on the bottom hinge and replace the top hinge and top hinge mat.
5. Replace top hinge cover.
6. Push the plug buttons into the original screw holes.

***Water Supply***

The water supply should be ready at the point of installation. The water supply pressure should be a minimum of 15 psig with a static pressure not more than 80 psig. (A wall outlet directly behind the ice machine will make installation easier.)

***IMPORTANT:***

- *All installations must be in accordance with local plumbing code requirements. Professional installation is recommended.*
- *Make certain that the hoses are not pinched or kinked or damaged during installation.*
- *Check for leaks after connection.*

**Tools required:** 1/2” open-end wrenches, Phillips screwdriver

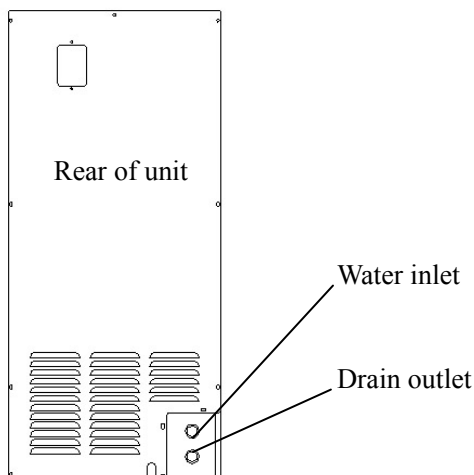

### **Connecting the water line:**

1. Turn off main water supply. Turn on the nearest faucet long enough to clear the line of water.
2. Find a 1/2" to 3/4" vertical cold water pipe near the installation location. The distance should be less than 9 feet. The water supply hose provided with the ice maker is about 9 feet.
3. A shut-off valve must be installed to the main water supply. If the water pipe has a plain piece of copper tubing, attach a 1/4" O.D. compression union to the tubing and remove the nut.
4. Connect nuts of water supply hose to the tap, and connect the other end with the water inlet. Tighten firmly by hand, then one-half turn with wrench.
5. Turn on main water supply and tap. Check for water supply connections leaks. Tighten every connection (including connections at the water inlet).

### ***IMPORTANT:***

***When you connect the water supply hose and the drain hose, pay attention to the indications of "Water inlet" and "Drain outlet" on the machine.***

### ***Drain***

***You must connect the drain line before using the ice maker. (The dual drainage feature of earlier models has been modified to simplify the drainage procedure.) Follow the steps outlined below.***

### **Connecting the drain line:**

**NOTE: If there is a drain line near the ice maker or the ice maker will be used as an outdoor unit, the best choice is to drain water to the drain line through the drain hose provided with ice maker.**

1. Locate the floor drain near the ice maker. The distance should be less than 5 feet since the length of the long drain hose provided with the ice maker is about 5 feet.  
Find the drain outlet on the back of ice maker, then take off the rear drainage plug. Connect the nut of the drain outlet to the water draining hose, and insert the other side of the hose into the drain line.  
*NOTE: The drain hose should never be allowed to hang or loop higher than the bottom of the ice storage bin.*
2. All horizontal runs of drain lines must have a fall of 1/4" per foot. An air gap will likely be required between the ice maker drain hose and the drain/waste receptacle. A stand pipe with a trap below it would be acceptable for the drain/waste receptacle. A floor drain is also acceptable.
3. Pour 1 gallon of water into the ice storage bin to check for leaks at all drain connections and at the nut of the drain water hole. Tighten any connections or nuts that leak.

***IMPORTANT: This ice maker is not a freezer. Infrequent drainage will cause a high rate of melting in the ice storage bin.***

## ***Installation Types***

This ice maker has been designed for Mobile (free-standing), Enclosed (as under a cabinet) or Built-in (sealed) installation, indoor or outdoor. In any case, there must be adequate air space around the unit for proper ventilation. (See diagrams on page 8.)

### **Mobile installation:**

A mobile installation will allow you to install the ice maker free-standing in any place you desire provided you have access to a water supply. You must follow the stated instructions for

- a. Electrical requirements
- b. Water supply
- c. Leveling the ice maker

### **Enclosed Installation:**

An enclosed installation will allow you to install the ice maker under a cabinet or inside a kitchen cabinet provided the required clearance space around the ice maker is respected. This installation has the same requirements as a mobile installation.

### **Built-in Installation:**

If this method of installation is chosen, it will still be necessary to allow adequate ventilation space around the unit. The following additional items must be observed.

1. Place ice maker in front of installation location. Remove the legs and place the unit flat on the floor or on a platform depending on your installation requirements.
2. The water supply line must be plumbed before connecting to the ice maker.
3. Connect the drain hose.
4. Turn on main water supply and tap. Check for water supply connection leaks. Tighten every connection (including connections at the water inlet).
5. If the electrical outlet for the ice maker is behind the cabinet, plug in the ice maker.
6. Push the ice maker into position.
7. Seal all around the cabinet to the floor with an approved caulking compound.

# Operation

## *Final Check List before Operation*

1. Have all packing materials and tape been removed from the interior and exterior of the ice maker?
2. Did you clean the ice storage bin?
3. Have the installation instructions been followed, including connecting the machine to water and electricity?
4. Has the machine been leveled?
5. Is the ice maker in a site where the ambient temperature is between 45°F (7°C) and 110°F (43°C) and the water temperature within 41°F (5°C) and 90°F (32°C) all year round?
6. Has the water supply pressure been checked to ensure a minimum of 15 psig with a static pressure not to exceed 80 psig?
7. Is there a clearance of at least 2/5" at the rear, and 1" at the top and 1/5" at the sides for proper air circulation?
8. Has the power supply voltage been checked or tested against the nameplate rating? And has proper grounding been installed for the ice maker?
9. Is the ice maker plugged in?
10. Have you turned on the main water supply and the tap?
11. Have you checked for leaks at all water supply connections?

## *Operating Method*

1. Turn on the water tap and let the water trough fill. Then set the Power switch on the front panel to the ON position. The ice maker will start working automatically.

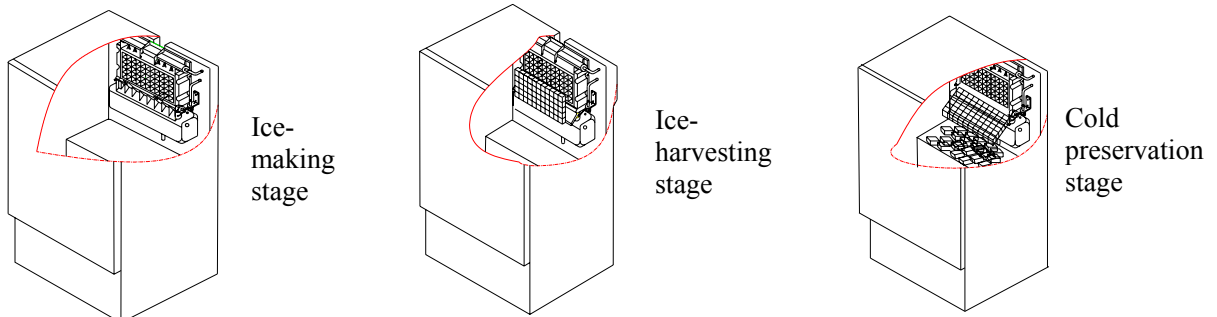



2. After three minutes, the machine will automatically go into the ice-making stage, and the sound of flowing water will be heard.
3. When the batch of ice has been fully formed, the ice will automatically be harvested to the ice storage bin.
4. When the ice storage bin is full, the sheet of cubes does not fall completely and it holds the ice-full probe open. The machine stops making ice and automatically progresses to the cold preservation stage. During this stage, the compressor works regularly to keep the temperature low to reduce ice melting.
5. The unit will start making ice again after the ice cubes are removed. Then the ice-full probe swings back to operating position.

***IMPORTANT:***

- *Although the unit has been tested and cleaned at the factory, due to long-term transit and storage, the first batch of cubes must be discarded.*
- *Never turn the water supply tap off when the ice maker is working.*
- *Never touch the evaporator when the machine is running!*
- *Except to take ice from the unit, keep the door closed to reduce ice melting and insure proper ice formation.*

## ***How the Machine Makes Ice***

Turn the Power switch to the ON position. The Power indicator light will light and the machine will automatically go into the ice-making stage.

There are two distinct cycles: freeze and harvest.

During the freeze cycle, water flows to the evaporator surface. In the harvest cycle, the ice is released. A complete cycle can take 15 to 40 minutes, depending on temperature and operating conditions.

**Freeze:** During the freeze cycle the compressor is pumping refrigerant, the fan motor is blowing air, and the water pump is circulating water. When the batch of ice has been fully formed, the ice maker stops the freeze cycle and begins the harvest cycle.

**Harvest:** During the harvest cycle the compressor is still operating, but the water pump has stopped. The hot gas valve opens, diverting hot refrigerant gas into the evaporator. The hot refrigerant gas warms the evaporator, causing the cubes to slide, as a unit, off the evaporator and into the storage bin. The freeze cycle will restart when all the cubes have been harvested.

## *How the Machine Uses the Water*

The ice maker begins with a fixed charge of water that is contained in the water trough. As the water flows to the freezing evaporator surface, the portion of water that does not contain mineral impurities will freeze and stick to the ice cube molds. The water containing impurities falls back into the water trough. During the ice-making process, fresh water enters the water trough continuously as the water from the trough freezes continuously on the evaporator.

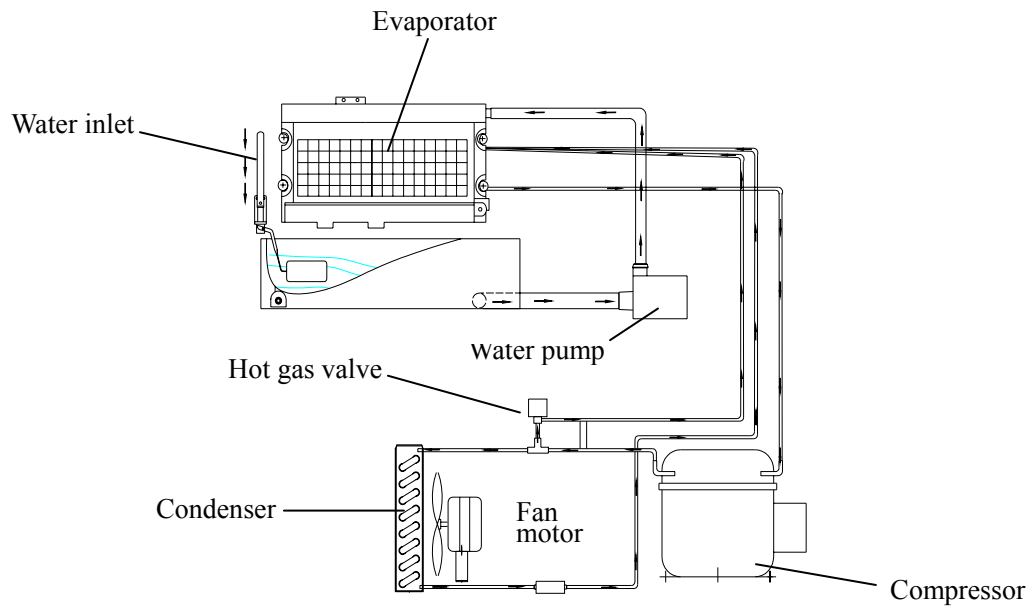

## ***Normal Sounds***

Your new ice maker may make sounds that are unfamiliar to you. Most of the new sounds are normal. Hard surfaces like the floor and walls can amplify the sounds. The following describes the kinds of sounds that might be new to you and what may be causing them.

- Rattling noises may come from the flow of the refrigerant or the water line. Items stored on top of the ice maker can also make noises.
- The high-efficiency compressor may make a pulsating or high-pitched sound.
- Running water may make a splashing sound.
- You may hear air being forced over the condenser by the condenser fan.
- During the harvest cycle, you may hear the sound of ice cubes falling into the ice storage bin.

## ***Preparing the Ice Maker for Long Storage***

If the ice maker will not be used for a long time, or is to be moved to another place, it will be necessary to drain the system of water.

1. Shut off the water supply at the main water source.
2. Disconnect the water supply line from the water inlet.
3. Shut off the electric supply at main electrical power source.
4. Take out the ice storage bin to remove remaining ice and water. Dry it.
5. Connect the drain hose to drain out water completely, then plug up the drain outlet after finishing.
6. Pull off the drainage tube of the water trough to drain off all water.
7. Leave the door open to allow for circulation and to prevent mold and mildew.
8. Leave water supply line and power cord disconnected until ready to reuse.

### ***IMPORTANT:***

- *Do not touch the power plug when your hands are wet.*
- *Never unplug the unit by pulling on the plug.*

# Cleaning and Maintenance

## CAUTION

If the ice maker is left unused for a long time, before the next use it must be thoroughly cleaned. Follow carefully any instructions provided for cleaning or use of sanitizing solution. Do not leave any solution inside the ice maker after cleaning.

Periodic cleaning and proper maintenance will ensure efficiency, top performance, and long life. The maintenance intervals listed are based on normal conditions. You may want to shorten the intervals if you have pets, or there are other special considerations.

### What should not be done

Never keep anything in the ice storage bin other than ice: objects like wine and beer bottles are not only unsanitary, but the labels may slip off and plug up the drain.

### What parts should be kept clean

There are 5 things to keep clean:

1. The exterior
2. The interior
3. The condenser
4. Water distribution tube
5. The ice-making system

## WARNING

Before proceeding with cleaning and maintenance operations, make sure the unit's power line is disconnected and the water line is shut off. (EXCEPTION: Cleaning of ice making system)

### *Exterior Cleaning*

The door and cabinet may be cleaned with a mild detergent and warm water solution such as 1 oz of dishwashing liquid mixed with 2 gallons of warm water. Do not use solvent-based or abrasive cleaners. Use a soft sponge and rinse with clean water. Wipe with a soft clean towel to prevent water spotting. Stainless steel can discolor when exposed to chlorine gas and moisture. Clean stainless steel with a mild detergent and warm water solution and a damp cloth. Never use an abrasive cleaning agent.

## ***Interior Cleaning***

The ice storage bin should be sanitized occasionally. Clean the trough before the ice maker is used for the first time and reused after stopping for an extended period of time. It is usually convenient to sanitize the trough after the ice-making system has been cleaned and the storage bin is empty.

1. Disconnect the power to the unit.
2. Open the door and take out the removable ice storage bin. With a clean cloth, wipe down the interior of the unit with a sanitizing solution made of 1 ounce of household bleach and 2 gallons of hot water (95°F to 115°F).
3. Rinse thoroughly with clear water.
4. Connect a hose to the drain outlet at the rear of the unit to drain water completely.
5. Put the ice storage bin inside the unit.
6. Reconnect power to the unit.

The ice scoop should be washed regularly. Wash it just like any other food container.

### **WARNING**

DO NOT use solvent-based cleaning agents or abrasives on the interior. These cleaners may transmit taste to the ice cubes and damage or discolor the interior.

## ***Condenser Cleaning***

A dirty or clogged condenser prevents proper airflow, reduces ice making capacity, and causes higher-than-recommended operating temperatures that may lead to component failure. Have the condenser cleaned at least once every six months.

1. Unplug the ice maker or disconnect power.
2. Remove the 2 screws on the front cover and gently pull it off.
3. Locate the condenser filter. This can be lifted out and cleaned with a brush or flowing water.
4. Remove dirt and lint from condenser fins and the unit compartment with a brush attachment on a vacuum cleaner.
5. Put back the filter and reassemble the front cover.
6. Plug in the ice maker or reconnect power.

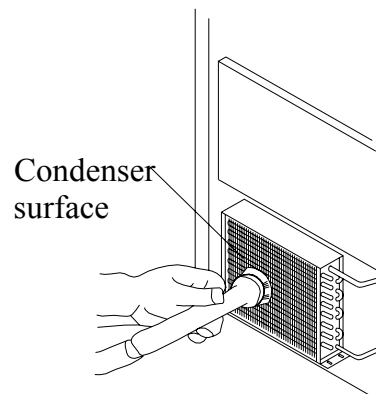



## **WARNING**

DO NOT touch the condenser fins. They are sharp and can be damaged easily.

### ***Water Distribution Tube Cleaning***

When you find that the ice cubes are incompletely formed or the output of ice cubes is low, the water distribution tube may be blocked. Set the Power switch to OFF, rotate the water distribution tube, and locate the holes in the distribution tube. Using a toothpick or similar tool, dredge the holes, then rotate the water distribution tube back to its original position. If the tube is badly blocked, clean it as follows:

1. Shut off the water supply.
2. Disconnect the water hose from the distribution tube.
3. Lift the right side up, then remove the distribution tube.
4. With a brush, clean the tube with a dilute solution of warm water and a mild detergent such as dishwashing liquid. After removing the dirt and lint from the surface, rinse the tube with clean water.
5. Replace the distribution tube
6. Reconnect the water supply.

### ***Ice-Making System Cleaning***

Minerals that are removed from water during the freezing cycle will eventually form a hard, scaly deposit in the water system. Cleaning the system regularly helps remove the mineral scale buildup. How often you need to clean the system depends upon how hard your water is or how effective your filtration may be. With hard water of 15 to 20 grains/gal. (4 to 5 grains/liter), you may need to clean the system as often as once every 6 months.

1. Make sure that all the ice is off the evaporator. If ice is being made, wait until the cycle is completed, then turn the machine OFF at the Power switch.
2. Remove all ice from the storage bin.
3. Keep the ice maker connected to the water supply. Pour 8 oz. of Nickel-Safe Ice Maker Cleaner Solution into the water trough. After about 5 minutes, set the Power switch to ON. At the same time press the Clean switch on the front of the unit, and the Clean indicator light will light, then initiate the Cleaning cycle. The machine will run the Automatic Clean Mode.

*NOTE: The unit will automatically shut down the Cleaning program after 30 minutes, or you can stop it by pressing the Clean switch again, and the machine will automatically progress to the ice-making stage.*

4. Allow 20 minutes for proper cleaning. After cleaning, turn the machine OFF at the Power switch. Drain off the waste water to a container by means of the drain hose at the front of the water trough.

*NOTE: Do not drain off the waste water to the inside of the cabinet.*

5. Repeat steps 3 and 4 (without Ice Maker Cleaning Solution) 3 times to rinse the ice making system.

*NOTE: The use of the Ice Maker Cleaner Solution in the water bin during the rinse is not needed.*

 **WARNING**

The ice machine cleaner contains acids.  
DO NOT use or mix with any other solvent-based cleaner products.  
Use rubber gloves to protect hands. Carefully read the material safety instructions on the container of the ice machine cleaner.  
DISCARD the first batch of ice produced after cleaning.

6. Prepare a sanitizing solution made of 1 ounce of household bleach and 2 gallons of hot water (95° to 115°F). Wipe the entire bin inside and outside, covering the entire surface of the walls.
7. Fill a spray bottle with the sanitizing solution and spray all corners and edges making sure to cover all surfaces with the solution.
8. Allow the solution to be in contact for at least 3 minutes, then dry.
9. Repeat step 5 to rinse the ice-making system one more time.
10. Set the Power switch to the ON position. The machine will return to the regular ice-making mode. Discard the first batch of ice.

# Major Functions

1. Completely automatic operation
2. When the ice storage bin is full of ice, the machine stops making ice and proceeds to the cold preservation stage automatically. It starts making ice again once the cubes are removed.
3. The fan motor responds to the ambient temperature. If it is cold, the motor will stop working to keep the cooling system in good working condition.
4. A sensitive probe and accurate timer enhance the performance of the ice maker.
5. Built-in compressor protection system



# Troubleshooting

## *Before Calling for Service*

If the unit appears to be malfunctioning, read through the OPERATION section of this manual first. If the problem persists, check the Troubleshooting Guide below and on the following page. The problem could be something very simple that can be solved without a service call.

## Troubleshooting Guide

<b>Problem</b>	<b>Possible Cause</b>	<b>Probable Correction</b>
The machine doesn't operate.	The icemaker is unplugged.	Plug the ice maker in.
	The fuse is blown.	Replace fuse – if this happens, call for service to check for a short circuit in the ice maker.
	The Power switch is set at OFF.	Turn the Power switch to ON.
	The ice storage bin is full of ice.	Remove some ice, making sure the ice-full probe is free of ice.
The water doesn't feed in after the machine starts.	The water supply tap is turned off.	Turn on the water supply tap.
	The water supply line is not properly connected.	Reconnect the water supply line.
Machine makes ice, but ice storage bin does not fill up with ice.	Condenser may be dirty.	Clean the condenser.
	The air flow to the ice maker may be obstructed.	Check the installation.
	The ambient temperature and water temperature are high, or machine is near some heat source.	Check the installation.
Water is leaking from the unit.	A few water drops fall to the floor when you open the door to take out ice from storage bin.	Normal condensation on the door or some water together with ice. Take care when you take out ice.
	Water supply connection leaking.	Tighten fitting. See “Connecting the Water Line”.

<b>Problem</b>	<b>Possible Cause</b>	<b>Probable Correction</b>
Cubes are partially formed or are white at the bottom.	Not enough water in the water trough.	Check if the water supply pressure is below 15 psig.
		Check water supply; filter may be restricted.
		Check for a water leak at the water trough.
Noise during operation	The legs are not leveled and locked.	Level and lock the feet. See “Leveling the Ice Maker”.
	Certain sounds are normal.	See “Normal Sounds”.
The ice maker stops suddenly while making ice.	The electricity is off.	Reconnect the power supply line.
	The room temperature is out of the stated range.	Cut off the electricity; let the ice maker stop working until the temperature returns to within the stated range.
	The ice storage bin is full of ice.	Remove some ice; be sure ice-full probe is free of ice.
The body of the ice maker is electrified.	The ground line isn't in the socket.	Use a socket meeting the required electrical standard.
Scaling occurs frequently inside the machine.	The water is too hard.	Using a water-softening device installed in front of the water inlet.
Water leaks from the ice storage bin.	The drain hole below the ice storage bin is blocked.	Pull out the ice storage bin and clean the drain hole.
	The drain hose is kinked or improperly placed higher than the floor of the ice storage bin.	Check the drain hose to make sure the water can drain out unhindered.