

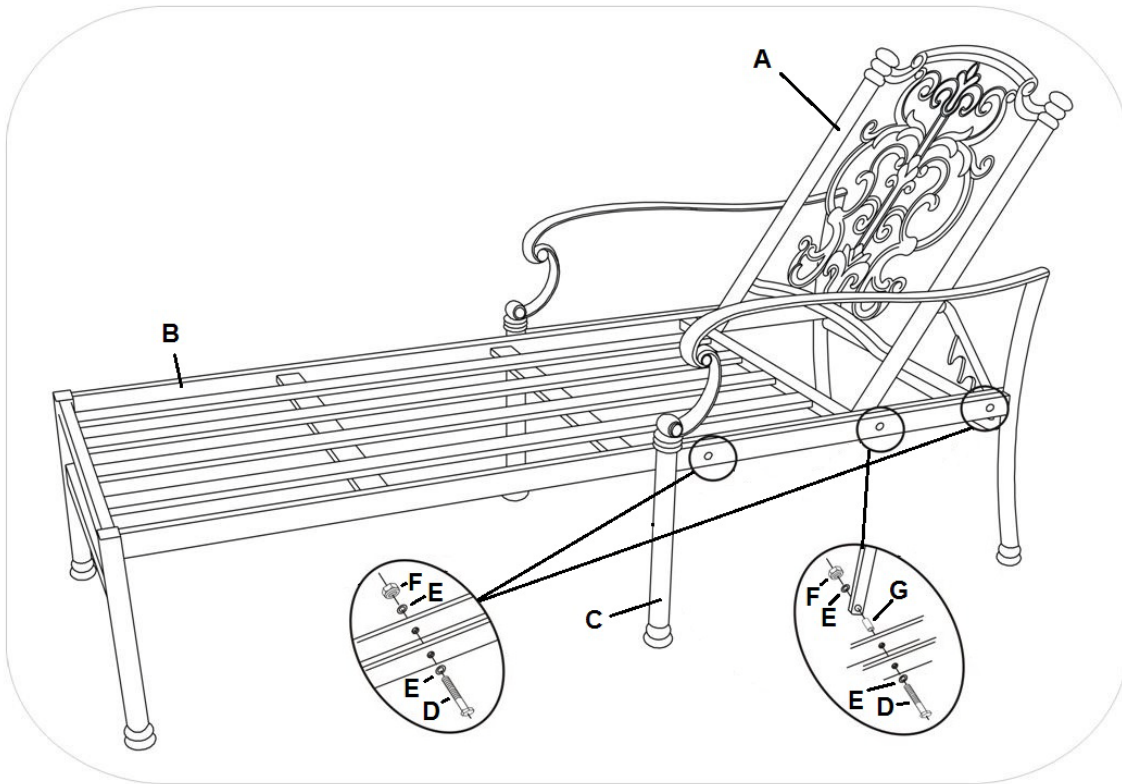







Assembly Instructions

BEFORE YOU BEGIN:

1. Identify all parts in the box against the “Parts” List.
2. Remove all protective material carefully and avoid cutting the surface of the furniture while removing wrapped material.



Part		Description	Qty	Part		Description	Qty
A		Backrest	1	D		Bolt	6
				E		Flat Washer	12
B		Bed	1	F		Nut	6
C		Leg	2	G		Plastic Spacer	2

Assembly Instructions

(FOR 201010-33)

ATTENTION:

1. **DO NOT** use power tools or over-tighten hardware during assembly.*

*Aluminum is soft metal, so over-tightening may strip threads or break the parts.

2. Please read these instructions carefully before assembling.

3. During assembly, place furniture against soft surfaces to avoid scratching the paint/ metal.

ASSEMBLY STEPS:

1. Lay the **BED (B)** on a flat, non-abrasive surface.
2. Line up the hole of **1 LEG (C)** to one side of the **BED**, and glide a **BOLT (D)** with a **FLAT WASHER (E)** into the leftmost and rightmost holes on the **BED**.
3. Secure the pieces together using **FLAT WASHERS (E)** and **NUTS (F)**. *Do not tighten at this time.
4. Line up the holes of the **BACKREST (A)** to the center hole of the **BED**, and glide a **BOLT (D)** with a **FLAT WASHER (E)** into that center hole of the **BED**.
5. Slide a **PLASTIC SPACER (G)** onto the **BOLT** so that it is located between the **BED** and **BACKREST**.
6. Slide the rest of the **BOLT** through the hole in the **BACKREST** and secure the end with a **FLAT WASHER (E)** and **NUT (F)**.
7. Repeat these steps with the other **LEG (C)**.
8. Tighten all bolts and nuts completely.
9. If needed, you may use the adjustable feet to level out the chaise lounge.

CARE INSTRUCTIONS:

Please **DO NOT** use acid or alkaline washing liquids to clean this product. Harsh cleaners can cause the powder-coated finish to stain and fade. Use a soft towel with mild liquid soap and water to clean the product, and dry with a soft cloth.