

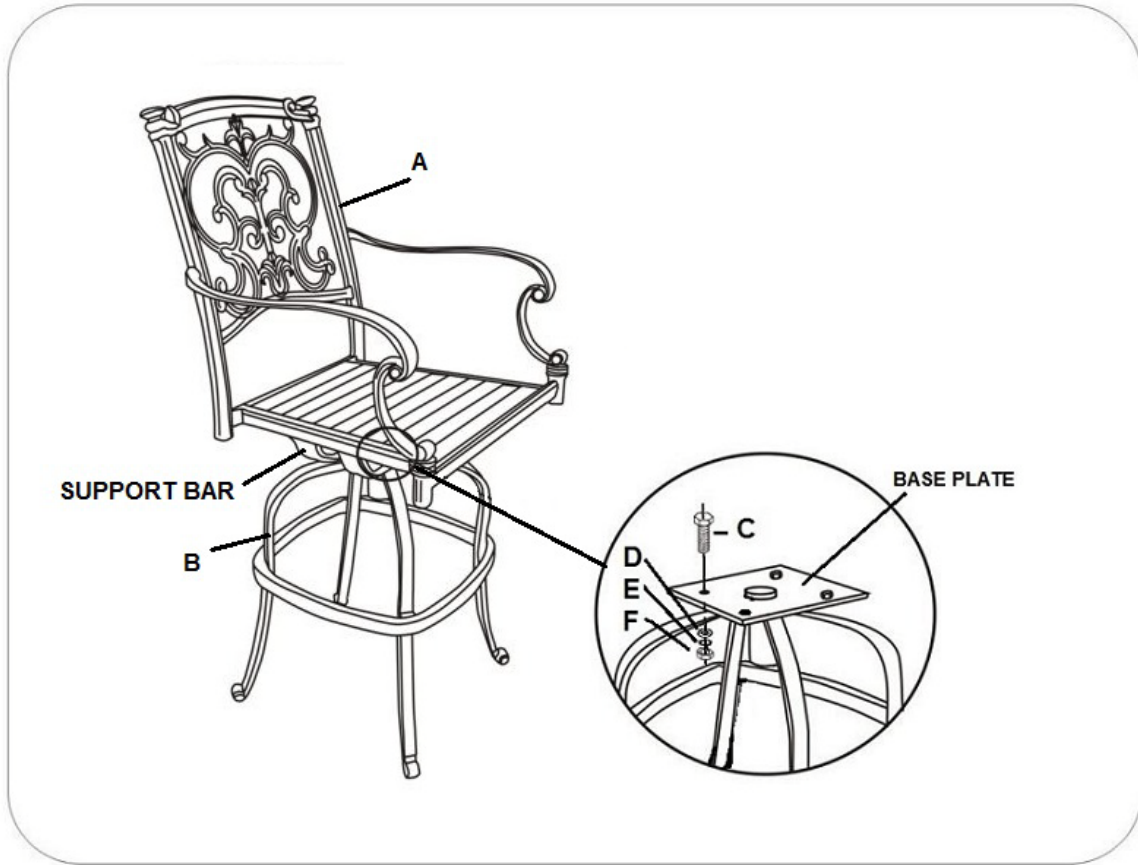





Assembly Instructions

BEFORE YOU BEGIN:

1. Identify all parts in the box against the “Parts” List.
2. Remove all protective material carefully and avoid cutting the surface of the furniture while removing wrapped material.



Part		Description	Qty	Part		Description	Qty
A		Seat	1	D		Flat Washer	4
B		Base	1	E		Lock Washer	4
C		Bolt	4	F		Nut	4

Assembly Instructions

(FOR 201010-7)

ATTENTION:

1. **DO NOT** use power tools or over-tighten hardware during assembly.*

*Aluminum is soft metal, so over-tightening may strip threads or break the parts.

2. Please read these instructions carefully before assembling.

3. During assembly, place furniture against soft surfaces to avoid scratching the paint/ metal.

ASSEMBLY STEPS:

1. Place the **SEAT (A)** upside-down onto a soft, nonabrasive surface.

2. Align the holes of the **plate** of the **BASE (B)** with the **support bars** of the **SEAT**.

3. Glide the **BOLTS (C)** through the aligned holes, and fasten the parts together using a **FLAT WASHER (D)**, **LOCK WASHER (E)**, and **NUT (F)**.

4. Tighten all bolts and nuts completely.

5. Flip the chair right side up and gently test that the bar stool swivels correctly.

6. If needed, you may use the adjustable feet to level out the bar stool.

CARE INSTRUCTIONS:

Please **DO NOT** use **acid or alkaline washing liquids to clean this product**. Harsh cleaners can cause the powder-coated finish to stain and fade. Use a soft towel with mild liquid soap and water to clean the product, and dry with a soft cloth.