

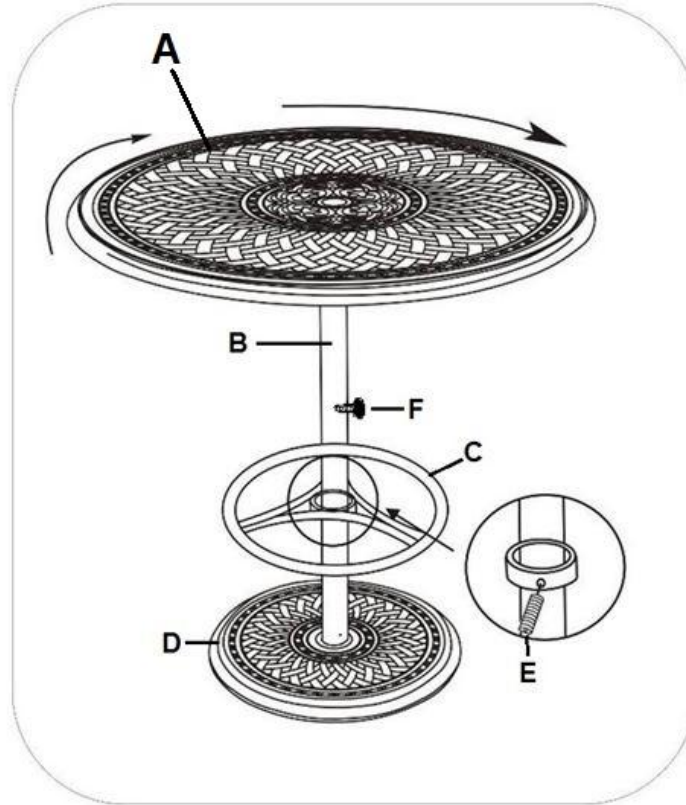





## Assembly Instructions

### BEFORE YOU BEGIN:

1. Identify all parts in the box against the “Parts” List.
2. Remove all protective material carefully and avoid cutting the surface of the furniture while removing wrapped material.



Part		Description	Qty
A		Table Top	1
B		Center Pole	1
C		Foot Rest	1
D		Base Plate	1
E		Bolt	3
F		Handle Bar	1

# **Assembly Instructions**

(FOR 201060-BJ)

## **ATTENTION:**

1. **DO NOT** use power tools or over-tighten hardware during assembly.\*

\*Aluminum is soft metal, so over-tightening may strip threads or break the parts.

2. Please read these instructions carefully before assembling.

3. During assembly, place furniture against soft surfaces to avoid scratching the paint/ metal.

## **ASSEMBLY STEPS:**

**IMPORTANT:** Before you begin, notice that the **CENTER POLE (B)** has two holes: one near the middle of the pole, and one near the bottom. The hole in the middle is threaded, and is where the **HANDLEBAR (F)** is to be inserted. The hole near the bottom is unthreaded, and is where trapped water is released. Orientation-wise, the side of the pole with the unthreaded hole needs to be at the bottom. There are no holes for the **FOOTREST (C)**.

1. Lay the **BASE PLATE (D)** flat on the ground.
2. Rotate the **CENTER POLE (B)** into the **BASE PLATE**.
3. Slide the **FOOTREST (C)** onto the **CENTER POLE** and tighten it to the pole at any level using the **BOLTS (E)**.
4. Screw the **HANDLEBAR (F)** into the threaded, center hole of the pole.
5. Carefully rotate the **TABLETOP (A)** onto the **CENTER POLE**. Do not force the components as it may damage the threading.
6. If needed, you may use the adjustable feet to level out the table.

## **CARE INSTRUCTIONS:**

Please **DO NOT** use acid or alkaline washing liquids to clean this product. Harsh cleaners can cause the powder-coated finish to stain and fade. Use a soft towel with mild liquid soap and water to clean the product, and dry with a soft cloth.