

PLATINUM SMART-HEAT™ ELECTRIC

Available in black and white, our Platinum Smart-Heat™ Electric heater is specifically suited for low-clearance and design-focused spaces. This slim-line, stainless-steel unit spreads comfort evenly in its space, all while minimizing light emission and blending seamlessly into the background with our recess mounting solutions.



2300W, 3400W & 4500W SERIES
BLACK | WHITE



2300W, 3400W & 4500W SERIES
BLACK | WHITE

SPECIFICATIONS

Reference the specification guide below to help you select the correct solution for your needs.

MODEL NUMBER	2300W SERIES	3400W SERIES	4500W SERIES
PRODUCT CODES PLATINUM ELECTRIC	BH0320003 BH0320007 BH0320019 BH0320020	BH0320005 BH0320008 BH0320021 BH0320022	BH3622000 BH3622004 BH3622001 BH3622005
PRODUCT CODES PLATINUM ELECTRIC MARINE	BH0320015 BH0320017 BH0320023 BH0320024	BH0320016 BH0320018 BH0320025 BH0320026	BH3622002 BH3622006 BH3622003 BH3622007
FUEL TYPE	ELECTRIC	ELECTRIC	ELECTRIC
COLOR	BLACK WHITE	BLACK WHITE	BLACK WHITE
HEAT AREA	65FT ²	108FT ²	143FT ²
RATED CURRENT**	220 - 240V/9.6A 208V/11.1A	220 - 240V/14.2A 208V/16.3A	220 - 240V/18.8A 208V/21.6A
MINIMUM FLOOR CLEARANCE	WALL 72" CEILING 96"	WALL 72" CEILING 96"	WALL 72" CEILING 96"
MOUNTING OPTIONS			
CEILING MOUNT	INCLUDED	INCLUDED	INCLUDED
WALL MOUNT	INCLUDED	INCLUDED	INCLUDED
RECESS KIT FLUSH MOUNT	✓	✓	✓
CEILING RECESS KIT PRODUCT CODES	BH3130017	BH3130027	BH3623000
NEW RECESS KIT LOW CLEARANCE	✓	✓	-
LOW CLEARANCE RECESS KIT PRODUCT CODES	BH3623009	BH3623008	-
CEILING POLE EXTENSION	✓	✓	✓
CEILING POLE (2') PRODUCT CODE	BH3130023-1	BH3130023-1	BH3623020
CEILING POLE (4') PRODUCT CODE	BH3130024-1	BH3130024-1	BH3623021
FREESTANDING	-	-	-
CONTROL OPTIONS			
ON OFF	✓	✓	✓
ON OFF PRODUCT CODE	BH3130010-1	BH3130010-1	BH3130010-1
DIMMER	✓	✓	✓
DIMMER PRODUCT CODE	BH3130011-1	BH3130011-1	BH3130011-1
MASTER REMOTE *	✓	✓	✓
MASTER REMOTE PRODUCT CODE	BH3130012-1	BH3130012-1	BH3130012-1

* Control up to six zones of heaters with unlimited heaters per zone from a single remote control. Dimmer control required. Works with dimming controllers. Remote control operates within 100ft of heaters.

** Available in 208V and 220-240V configurations.

Measurements displayed within this document are for reference only, for complete requirements see the installation/user manual. Bromic takes no responsibility for incorrect or non-compliant installations. All measurement in this document are displayed in inches.

DIMENSIONS

With a wide range of sizes available, find the ideal heater to suit your outdoor space.

CONTROL OPTIONS



ON | OFF CONTROL



DIMMER CONTROL



MASTER REMOTE

PROFILE

2300W

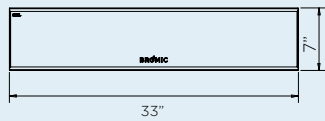

3400W

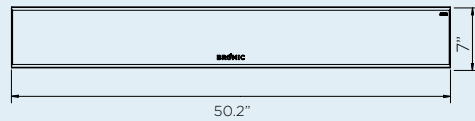

4500W

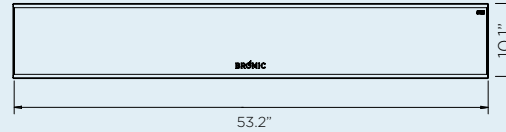

CEILING RECESS

CEILING RECESS FRAME 2300W

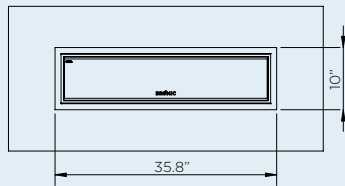

CEILING RECESS FRAME 3400W

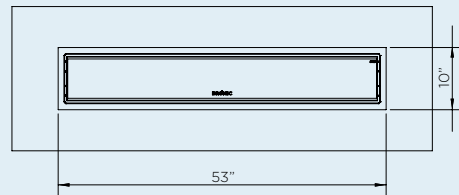

CEILING RECESS FRAME 4500W

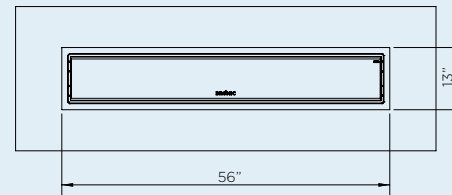

LOW CLEARANCE RECESS KIT
2300/3400W

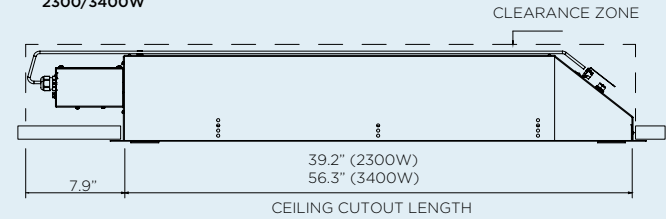

MINIMUM CAVITY OPTION 1
2300/3400W

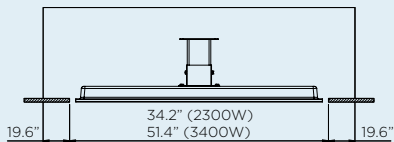

MINIMUM CAVITY OPTION 2
2300/3400W

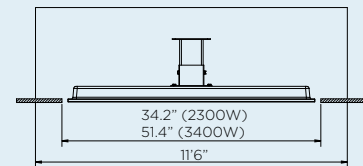

MINIMUM CAVITY FOR 4500W

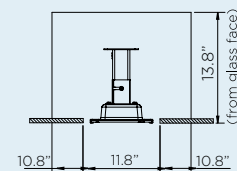
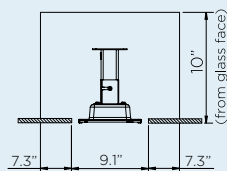
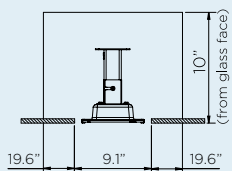
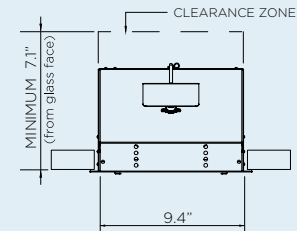
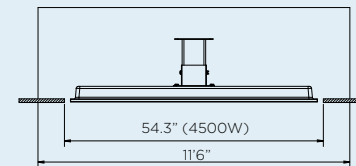

MOUNT OPTIONS

With a wide array of mounting options, Bromic offers solutions to compliment any decor and provide functionality for ambiance and comfort.

CEILING & WALL MOUNT

CEILING MOUNT CLEARANCE

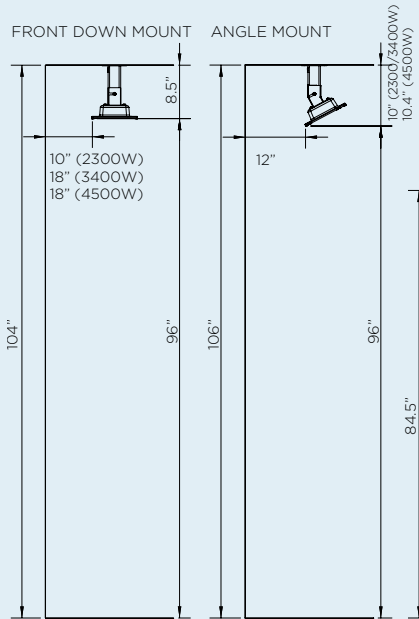

WALL MOUNT CLEARANCE 2300/3400W

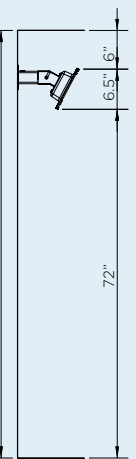

WALL MOUNT CLEARANCE 4500W

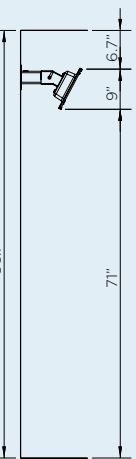

CEILING POLE CLEARANCE

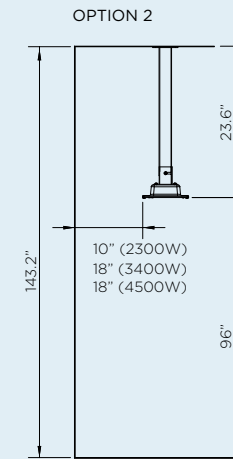
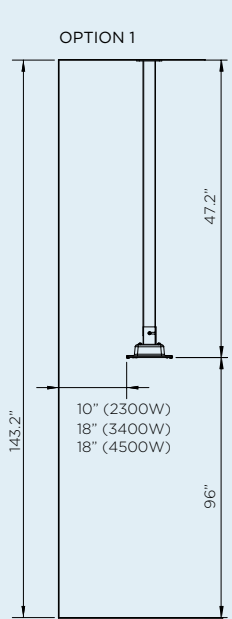

WALL BRACKET (INCLUDED)

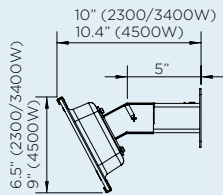

CEILING BRACKET (INCLUDED)

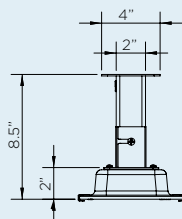

HEATING REACH

Creating ideal comfort levels, Bromic heaters offer a variety of heat distribution options to suit your outdoor heating needs.

HEAT AREA

2300W SERIES
 HEATING APPROXIMATELY 65FT²
 2300W HEATING POWER

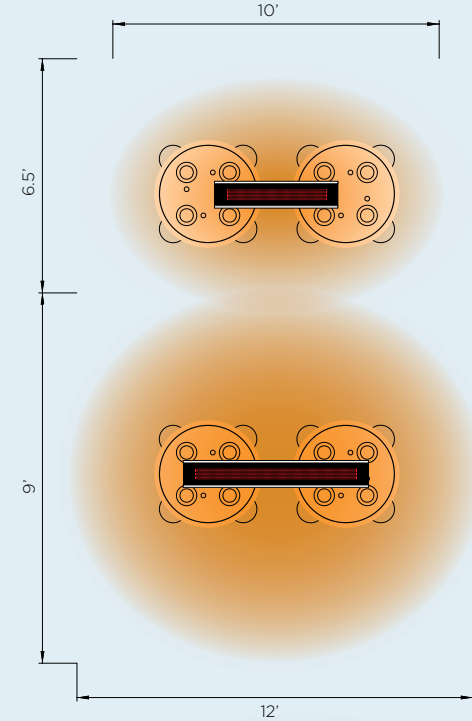

3400W SERIES
 HEATING APPROXIMATELY 108FT²
 3400W HEATING POWER

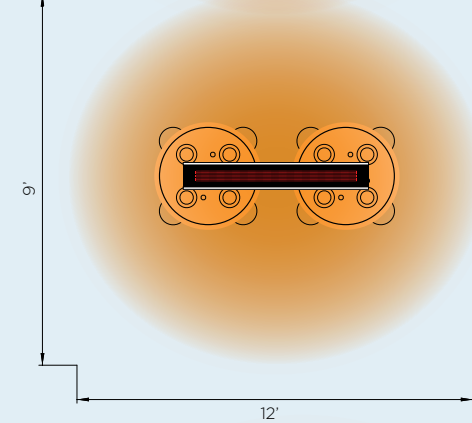

4500W SERIES
 HEATING APPROXIMATELY 143FT²
 4500W HEATING POWER

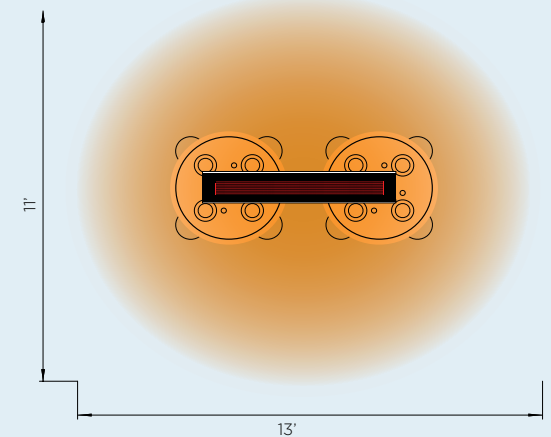



EXTEND YOUR COMFORT OUTDOORS
WITH THE SUPERIOR HEAT AND
AWARD-WINNING DESIGN OF OUR
SMART-HEAT™ OUTDOOR HEATERS.



VERSATILE MOUNTING SOLUTION
Minimal vertical clearance

HIGH PERFORMANCE CONSTRUCTION
304 stainless-steel & tinted ceramic screen

CLEAN, COMPACT AND ELEGANT DESIGN
For seamless integration



**COMPATIBLE WITH
SMART-WIRELESS
TECHNOLOGY**

**ADJUSTABLE MOUNTING
BRACKETS**
Allows for directional
heat distribution

BROMIC.COM

ASIA PACIFIC | NORTH AMERICA | EUROPE

Bromic pursues a policy of continuing improvement in design and performance of its products. The right is therefore reserved to vary specifications without notice.