

### TRANSITIONS AND DAMPERS

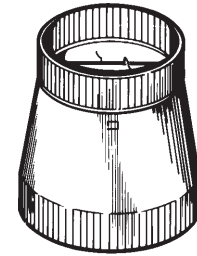

**Model 411 Transition**

- 3¼" x 10" to 6" round

**Model 412H Transition**

- 3¼" x 10" to 7" round

**Model 413 Transition**

- 3¼" x 10" to 8" round

All models above -  
30 GA galvanized steel  
construction

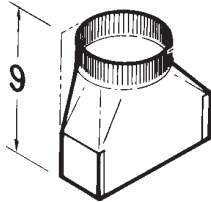

**Model 424 Transition**

- 4½" x 18½" to 10" round  
horizontal, rear discharge
- 26 GA galvanized steel  
construction

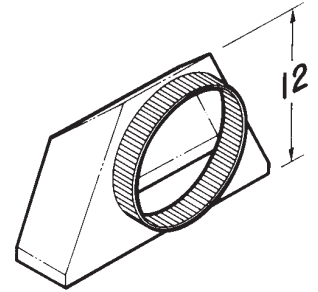

**Model 414 Transition**

- 10" round to 8" round
- 24 GA galvanized steel

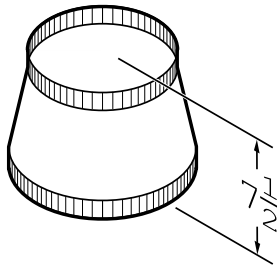

**Model 427 Transition**

- 4½" x 18½" to 10" round  
horizontal discharge
- 26 GA galvanized steel  
construction

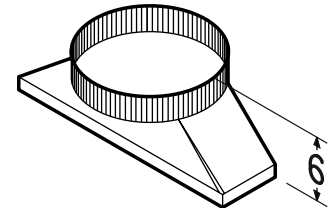

**Model 423 Transition**

- 4½" x 18½" to 10" round  
- vertical discharge
- 26 GA galvanized steel  
construction

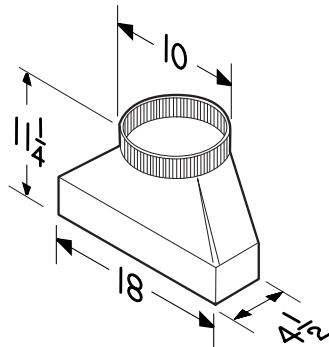

**Model 453  
Transition**

- 4½" x 18½" to 10"  
round horizontal,  
left discharge
- 26 GA galvanized  
steel construction

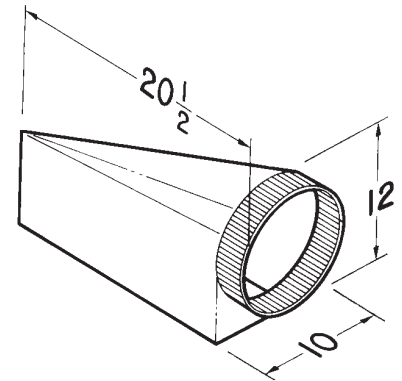

**Model 454  
Transition**

- Same as Model  
453 except -  
horizontal right  
discharge

Broan-NuTone LLC Hartford, Wisconsin www.broan.com www.nutone.com 800-558-1711  
Broan-NuTone Canada Mississauga, Ontario www.broan.ca 877-896-1119

REFERENCE	QTY.	REMARKS	Project
			Location
			Architect
			Engineer
			Contractor
			Submitted by Date

**Model 459 Transition**

- 3 1/4" x 14" to 8" round - vertical discharge
- 30 GA galvanized steel construction

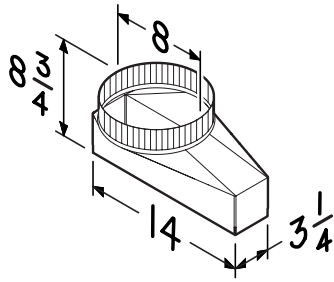

**Model T460 Transition**

- 3 1/4" x 14" to 7" round - vertical discharge
- 30 GA galvanized steel construction

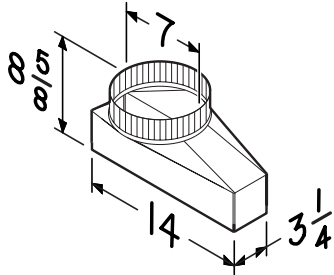

**Model T462 Transition**

- 3 1/4" x 14" to 6" round - vertical discharge
- 30 GA galvanized steel construction

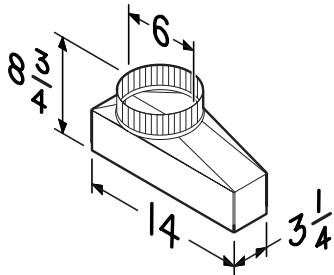

**Model 472 Transition / Damper**

- 10" round to 8" round
- Spring-loaded aluminum louvers
- Rubber stops
- 24 GA galvanized steel

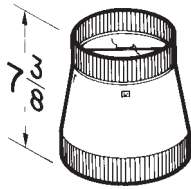

**Model 475 Transition**

- 6" round to 4" round
- Black, polymeric construction

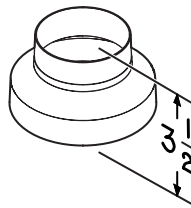

**Model 475B Transition**

- Six-pack of Model 475

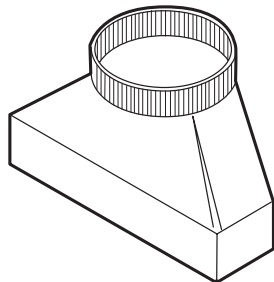

**Model T81212 Transition**

- 8" x 12" to 12" round
- 28 ga. galvanized steel

**Model S99610015 Transition**

- 8" x 12" to 10" round male - vertical discharge
- 26 GA galvanized steel construction

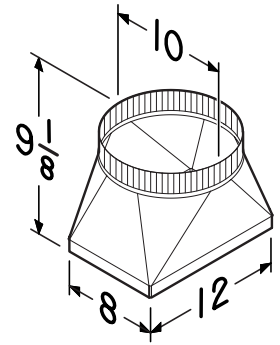

**Model S99610028 Transition**

- 8" x 12" to 10" round female - vertical discharge
- 26 GA galvanized steel construction

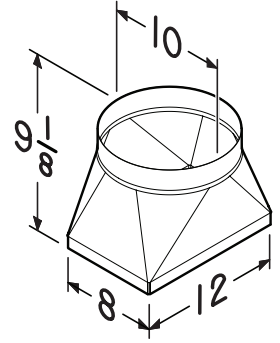

**Model BP87 Damper**

- 7" round
- Extruded steel with electrically-bonded epoxy finish
- .016 Aluminum louvers

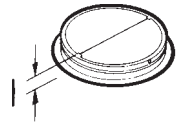

**Model 97 Damper**

- 7" round
- 28 GA galvanized steel
- Aluminum louvers

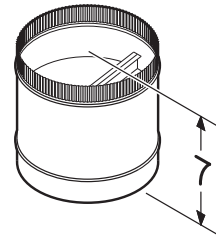

**Model 99 Damper**

- 9" round
- .032 All Aluminum construction
- Spring-loaded aluminum louvers

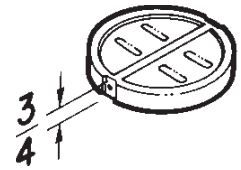

**Model 421 Damper**

- 10" round
- 24 GA galvanized steel with aluminum louvers

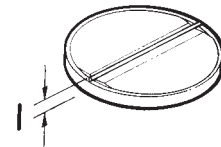

**Model 438 Damper**

- 8" round
- 24 GA galvanized steel with aluminum louvers

