

Certifications & Information

- NSF Certified
- UPC & cUPC Certified
- Lead-Free Construction
- ADA Approved
- Limited Lifetime Warranty

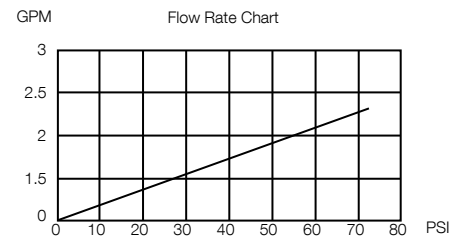

Tools

Gather the necessary tools as shown to complete the installation of this faucet.



Adjustable Wrench

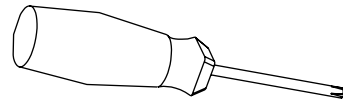

Phillips Screwdriver

The following tools are optional:



Safety Glasses



Channel Lock



Pliers

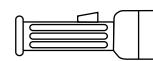

Flashlight

Configuration

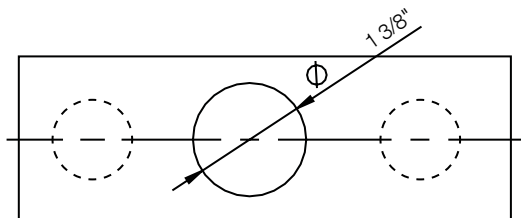

One-Hole Installation
Three-Hole Installation with Base Plate

Connect to water supply lines with TWO
3/8" Compression Faucet Connectors

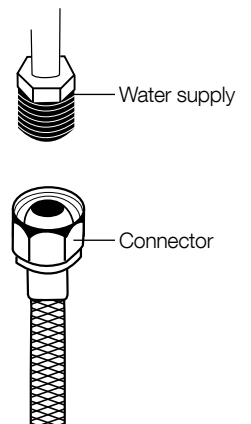

Faucet Installation

- A. Turn off the water supply. Remove the faucet with the mounting hardware attached from the package.
- B. Remove all mounting hardware from the shank.

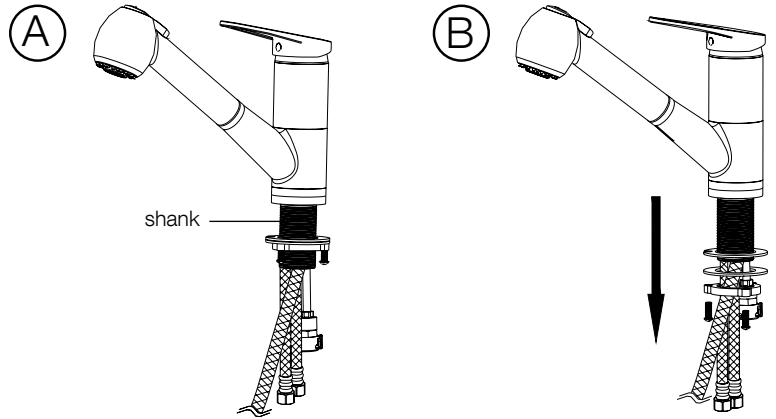

- C. Insert the shank of the faucet body into the hole of the sink deck. If installing a base plate, insert the faucet shank through the base plate first, and then into the holes of the sink deck.
- D. From the underside of the sink or mounting surface, attach the washer, followed by the lock nut, and screws onto the shank.

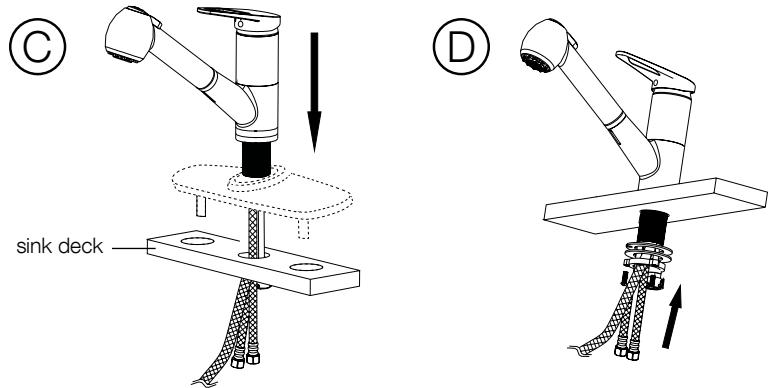

- E. Hand-tighten the lock nut until secure. Then, use a screwdriver to tighten each screw slightly until all are secure.
- F. Plug the spray hose into the quick connect at the base of the copper tube.

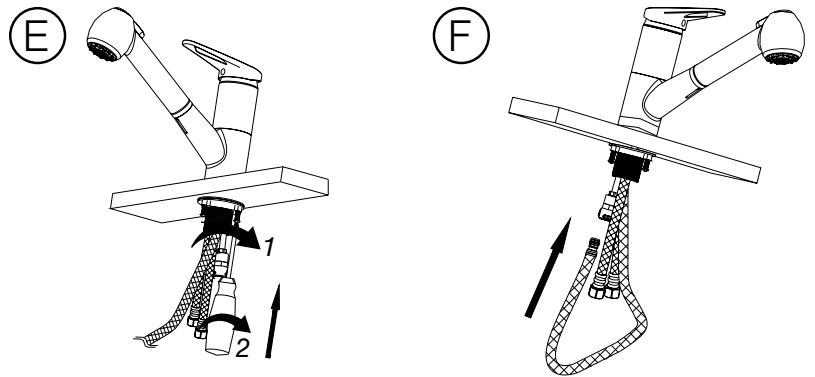

- G. Install the weights onto the hose using two screws. Position the weights two feet from the underside of the sink deck. Use a screwdriver to tighten the screws securely.

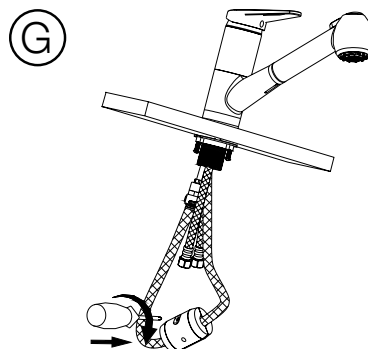

- H. Connect 3/8" compression fittings to each hose, and then to each corresponding water supply line. Secure each fitting with a 1/4 turn of a wrench.

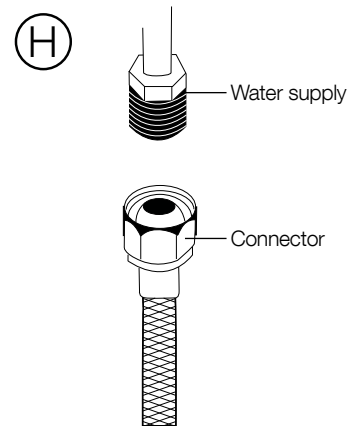

Important

Turn on the water supply SLOWLY, to test for leaks before completely opening the water lines.

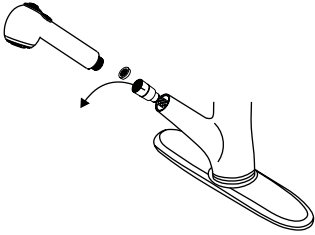
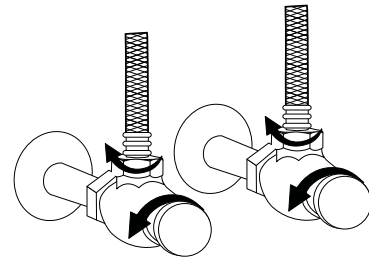

Pull the hand spray from the faucet body and disconnect it. Be careful not to lose the washer between the hand spray and the hose. Once the hand spray is disconnected, remove the aerator washer from the hose and direct the open end of the hose into the sink. Operate the faucet handle in the hot and cold positions to flush each line for at least one minute each. When complete, place the washer back into the end of the hose and reconnect the hand spray. Place the hand spray back into the faucet body.

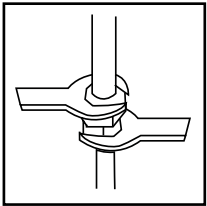

To prevent damage to the tube body, tighten the connections by carefully using two wrenches as shown. Use caution to not bend the stem. Check for leaks.

Maintenance & Cleaning

The faucet can be cleaned by rinsing with clear water or washing with mild detergents. Dry the faucet with a clean, soft cotton cloth. CAUTION: do not use any cleaning agents containing acids, abrasives, or other harsh chemicals.

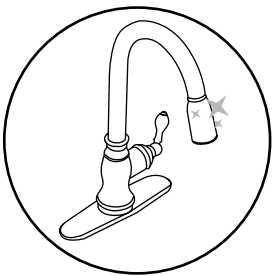

Simply rinse and dry faucets with a soft towel every week to prevent mineral deposits from forming. Clean spills and splatters as they happen. Do not let soap, toothpaste or other contaminants dry on the faucet, this can stain or pit the finish. Use a mild soap and soft sponge or towel to remove residue. Rinse and dry thoroughly.



Never use an abrasive cleaner or rough sponge to clean or dry your faucet. Harsh cleaners could dull or scratch the finish. Use only a soft disinfectant that does not contain bleach or chlorine and apply with a soft towel.

Notes

Warranty Information

MR Direct warrants to the original consumer purchaser that our sinks and faucets will be free from defects in material and workmanship under normal use for the lifetime of the product. MR Direct may elect to repair or replace any defective MR Direct product covered by our warranty.

Our warranty does not cover defects caused by misuse, abuse, negligence, alterations, environmental conditions, improper installation, storage and handling; nor any labor expenses.

From time to time we will change design specifications and materials as conditions require and improvements are developed. We have no obligation to incorporate such changes in products we previously manufactured.

This warranty is in lieu of any and all other warranties, express or implied, including any warranties of merchantability and of fitness for a particular purpose; and excludes any incidental or consequential damages. No representative has the authority to change or enlarge the above warranty.

This warranty is only valid in the United States of America. Some states do not allow limitations on how long an implied warranty lasts or the exclusion or limitation of incidental or consequential damages, so the above limitations or exclusion may not apply. This warranty gives you specific legal rights, and you may also have other rights which vary from state to state.

One-Year Accessory Warranty

MR Direct warrants to the original purchaser that all of our accessories will be free from defects in material and workmanship under normal use for one full year.

Our warranty does not cover defects caused by misuse, abuse, negligence, alterations, environmental conditions, improper installation, storage and handling; nor any labor expenses. MR Direct may elect to repair or replace any defective MR Direct accessory covered by our warranty.