

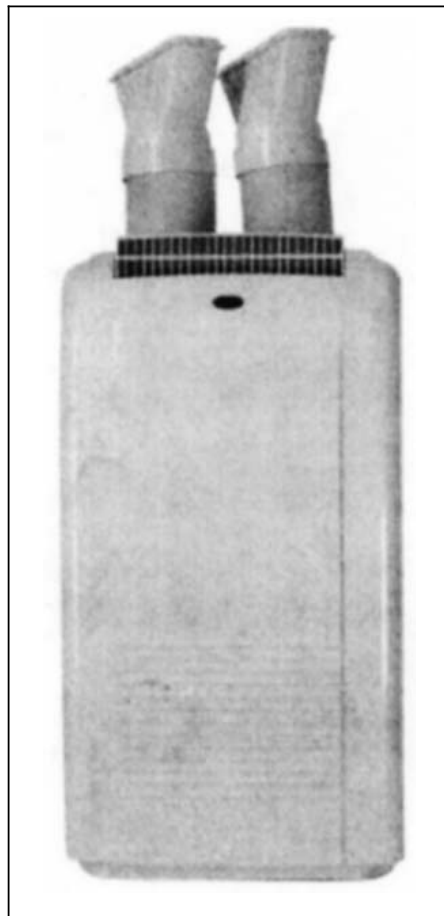

## **DUAL-HOSE PORTABLE AIR CONDITIONER**

### **USE AND CARE MANUAL**



**WA-9040DE · WA-9040DH · WA-1140DE**

**WA-1340DE · WA-1340DH**

Thank you for purchasing SPT Air Conditioner, please read the Use and Care Manual carefully before installing and using this appliance. Keep this manual for future reference.

# CONTENTS

<b>Table of Contents</b>	1
<b>Introduction</b>	2
<b>Features</b>	3
<b>Identification of Parts</b>	
Unit	3
Accessories and Window Kit	4
<b>Installation Instructions</b>	5
<b>Control Panel</b>	6
<b>Remote control</b>	7, 8
<b>Operating Instructions</b>	
Operating modes	9
Cooling	10
Dry	11
Smart mode	12
Timer settings	13
Setting the clock	13
Super and Heater	14
<b>Protection Features</b>	15
<b>Maintenance</b>	16
<b>Troubleshooting</b>	17
<b>Specifications</b>	18
<b>Warranty Info</b>	19
<b>Notes</b>	20

## Introduction

Thank you for choosing this portable air conditioner. It will provide you and your family with all of the “Home Comfort” requirements for your home, cottage or office. This appliance can be moved from room to room within your home and set-up in just minutes.

### Electrical Specifications

1. All wiring must comply with local and national electrical codes and be installed by a qualified electrician. Contact a qualified electrician with questions regarding the following instructions.
2. Check available power supply and resolve any wiring problems before installation and operation of this unit.
3. For your safety and protection, this unit is grounded through the power cord plug when plugged into a matching wall outlet. If you are not sure whether the wall outlets in your home are properly grounded, please consult an electrician. Do not use plug adapters or extension cords with this unit. If it is necessary to use an extension cord, use with heavy appliance extension cord only (available at most local hardware stores).

### Energy Saving Tips

- Please use the unit in the recommended room size. (Refer to [www.spt-usa.com](http://www.spt-usa.com)).
- Do not locate the air conditioner where furniture or other objects can obstruct the airflow.
- Keep blinds/curtains closed during the sunniest part of the day.
- Close the fireplace damper and floor or wall grills so that cool air does not escape through the chimney or ductwork.
- Keep the exhaust hose as short and straight as possible.
- If unit is to be operated throughout the day, turn on the unit early, before the noon heat hits.
- It is highly recommended to turn on the air conditioner when the room temperature is around 75°F. Do not wait until the room gets excessively hot.
- Keep the filters clean.

### Single Hose vs. Dual Hose

**Single Hose:** draws indoor air for both front cold air output and exhaust air (to cool compressor).

PROS:	<ul style="list-style-type: none"><li>• Fresh air is exchanged</li></ul>
CONS:	<ul style="list-style-type: none"><li>• Fresh air will delay the speed of ambient temperature drop</li></ul>

**Dual Hose:** draws indoor air for front cold air output and outdoor air for exhaust air.

PROS:	<ul style="list-style-type: none"><li>• If outside temperature is lower than ambient, compressor cools down faster and produces colder air output</li><li>• Ambient temperature drops quickly</li></ul>
CONS:	<ul style="list-style-type: none"><li>• Same air circulating within the room, resulting in decreased oxygen level and increased carbon dioxide</li><li>• If outside temperature is too high, compressor cannot be cooled – resulting in increased temperature of front air output.</li></ul>

**NOTE:** It is suggested to remove the air intake hose and use as single hose system when outside temperature is over 95°F.

## Features

This unit is equipped with the following features:

- **Re-Start IC:** Should there be a power outage, when power returns, unit will resume operating at last setting / mode.
- **Self-Evaporating Technology:** Recycles the condensed water and evaporates it out with the exhaust air, for added cooling efficiency as well as energy efficiency.
- **Smart Mode:** fuzzy logic operation
- **Super Mode:** for cooling only models
- **Heater Mode:** for units with heater option

## Identification of Parts

### Unit

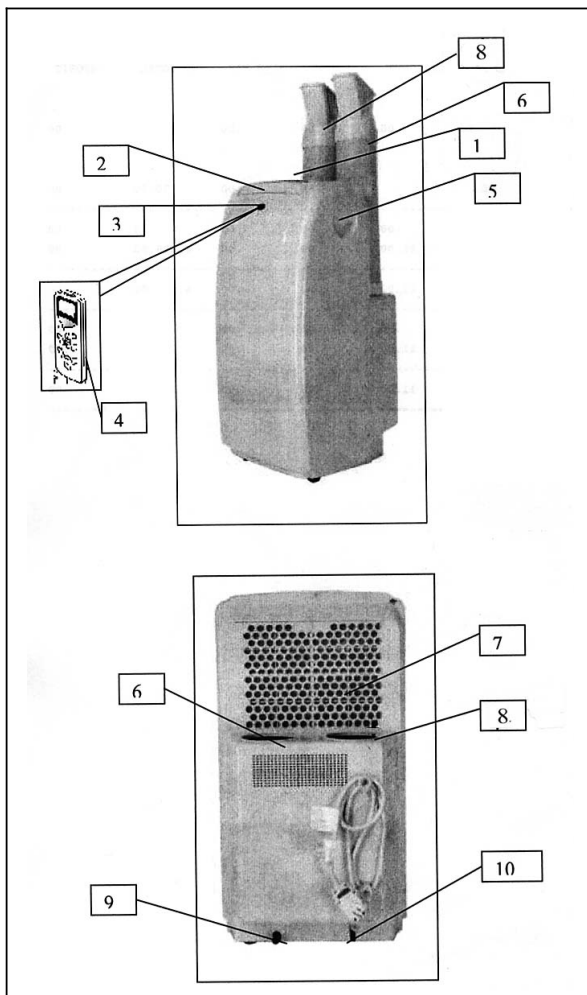

1. Control panel
2. Air outlet / louver
3. Remote signal receptor
4. Remote controller
5. Transport handle
6. Air exhaust hose
7. Evaporator air intake
8. Air intake hose
9. Drain port
10. Power supply

The images in this manual are based on the external view of a standard model. Consequently, the shape may differ from that of the air conditioner you have selected.



## Accessories

### Installation Accessories

PART & DESCRIPTION	QUANTITY
1. <b>Air inlet hose</b> Extends from 17 3/4" to 70 5/8"	1pc
2. <b>Air outlet hose</b> Extends from 17 3/4" to 70 5/8"	1pc
3. <b>Window exhaust adapter</b>	2pcs
4. <b>Adapter</b>	2pcs
5. <b>Window/patio door slider kit</b> From 28 3/8" up to 55 5/8"	1 set (3pcs)

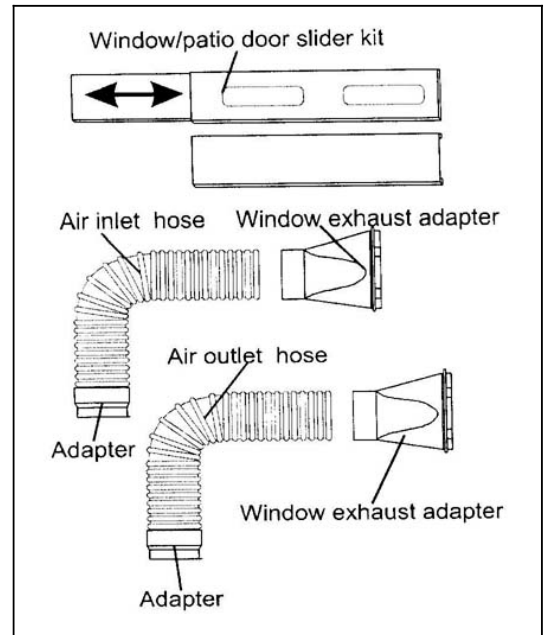

### Window Kit Installation

The window kit has been designed to fit most standard windows, with vertical or horizontal applications. However, it may be necessary for you to improvise or modify some aspects of the installation procedures for certain types of windows. Please refer to Figures 1 and 2 below for minimum and maximum window openings.

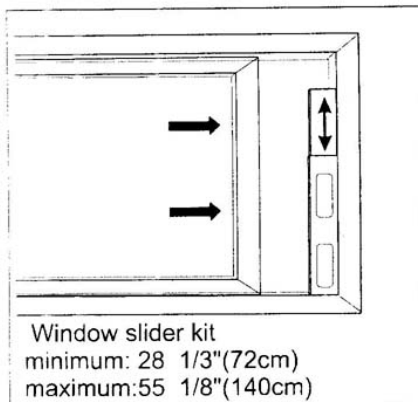

FIGURE 1

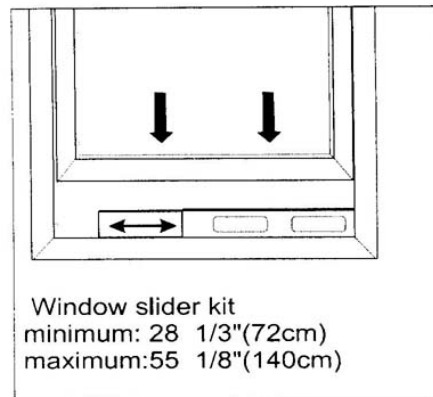

FIGURE 2

## Installation Instructions

### Selecting the best location

- Best to place the unit near a window, patio door or French window. The shorter you can keep the intake/exhaust hoses, the more efficient the unit will run.
- Keep a minimum space of 20 inches between the back of the unit to the wall or other obstacles.

### Installing instructions

1. Install the adapters and window exhaust adapters to the hoses.
  2. Fix the adapter end of the hose to the unit.
  3. Extend the hose to the destined window/door to insure enough clearance.
  4. Attach hose to slider kit
  5. Repeat above steps for the other hose.
  6. Install the slider kit to the window / door and adjust height accordingly. There are small openings on the side of the slider kit. Once the desire height is set, insert a small screw (not supplied) to keep in place.
- Do not block the air outlet or intake with protective grid, curtain, shutter or other obstacles.
  - Keep a minimum clearance of 8" between the ends of air hoses.
  - Try to keep the air hoses as straight as possible, as in Figure 3.

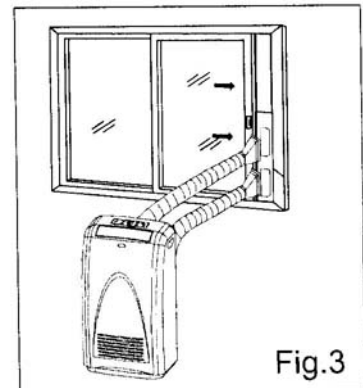

### Installation Sequence

1. Select a suitable location, with easy access to an electrical outlet.
2. Install the flexible air hoses and adjustable slider kit as depicted in Figure 3.
  - For COOLING mode, please install both the air intake and air exhaust hose. Cooling capacity will decrease when using single air hose. However, to prevent compressor from overheating, when outdoor temperature is 35°C (95°F) or above, remove the air intake hose.
  - For DRY mode, remove air intake hose and install only the air exhaust hose.
2. For FAN and HEATER (Heating models), no hose installation required.
3. Plug unit to a grounded electrical outlet. Please select an appropriate power supply based on the requirements on the nameplate.
4. Press the power button to turn unit on.

**Note: Do not use an extension cord with this appliance. If an extension cord must be used, use heavy appliance extension cords only. (Available at most local hardware stores)**



## Control Panel

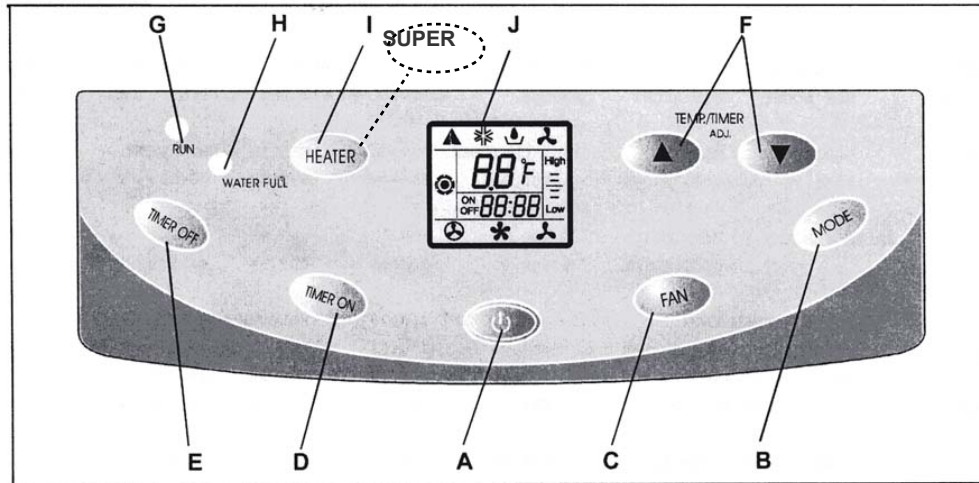

- A. ON/OFF button: to start or stop the appliance.
- B. MODE button: to select the operating mode. (Smart → Cooling → Dry → Fan only)
- C. FAN button:
  - Selects the fan speed. (Auto → High → Low)
  - Press and hold to start or stop auto-swing of louvers.
- D. TIMER-ON button: to set or cancel the timer-on operation.
- E. TIMER-OFF button: to set or cancel the timer-off operation.
- F. TEMP/TIMER buttons: to set clock, to set timer or to adjust temperature setting. Press ▲▼ buttons together to switch temperature display, °C to °F or vice versa.
- G. RUN indicator: lights up green when unit is operating.
- H. WATER FULL indicator: lights up red when water reservoir is full.
- I. HEATER/SUPER button:
  - HEATER (on Heater models) = turn heater on or off.
  - SUPER (on Cooling only models) = to enter or exit SUPER (fast cooling) mode.
- J. LCD display: displays temperature and mode settings. The LCD display on the unit corresponds to the LCD display on the remote, except for ambient temperature display.

Temperature Display	
On unit	<ul style="list-style-type: none"> <li>• When flashing, displays the set temperature</li> <li>• When steady, displays the ambient temperature</li> </ul>
On remote	Only displays the set temperature

# Remote Controller

The remote controller transmits signals to the main unit.

1. **ON/OFF BUTTON**  
To turn the unit ON or OFF
  2. **MODE BUTTON**  
Used to select the operating mode
  3. **FAN BUTTON**  
Used to select fan speed, in sequence: Auto, High, Low
  4. **TEMPERATURE SETTING BUTTONS**
    - Used to set the desired temperature
    - Used to set clock or set timer
    - If the ▲▼ buttons are pressed together, temperature display will switch between °C and °F
  5. **SWING BUTTON**
    - Press once for vertical swing of the louver
    - Press again to set the louver at a desired position
  6. **SMART BUTTON**  
Press to enter fuzzy logic operation, regardless if unit is ON or OFF
  7. **TIMER-ON BUTTON**  
Used to set or cancel timer-on function
  8. **TIMER-OFF BUTTON**  
Used to set or cancel timer-off function
  9. **HEATER BUTTON (for Heating models only)**  
Used to start or stop electrical heating mode
- SUPER BUTTON (for Cooling only models)**  
Used to start or stop fast cooling function

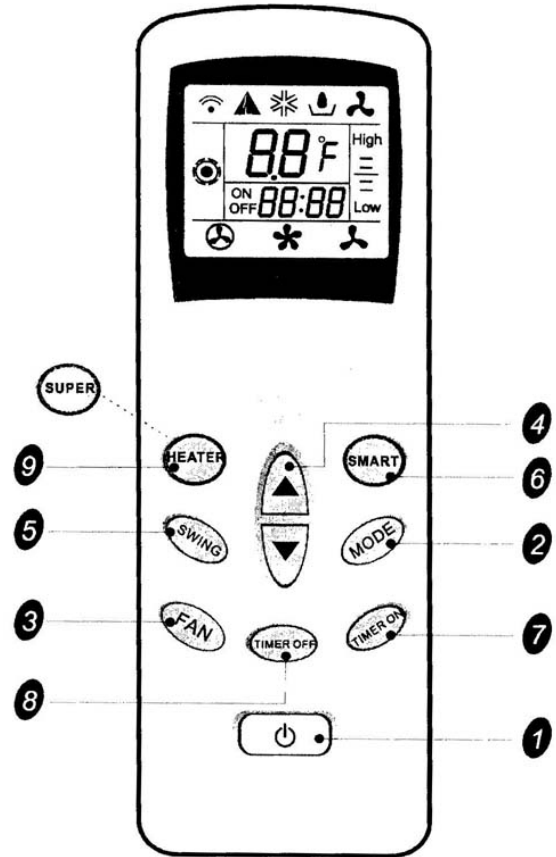

**KEY** (all buttons exist and correspond to the control panel, except: SUPER, SMART & SWING.)

	Signal transmit		Auto fan speed	High  Low	Used to regulate temperature in Smart or Dry mode (see page 12 "Smart Mode" for details)
	Smart indicator		High fan speed		
	Cooling indicator		Low fan speed		
	Dry indicator		Displays set temperature	ON OFF	Indicator of Timer-ON or Timer-OFF and displays real time
	Fan only indicator				
	Heater indicator available for models with heater only				

<b>Note</b> :	<b>Each mode and relevant function will be further specified in following pages.</b>
------------------	--

### **How to Insert Batteries**

- Remove the battery cover according to the arrow direction.
- Insert new batteries making sure the (+) and (-) match accordingly.
- Slide the cover back in position.

### **Note:**

- **Use 2 AAA (1.5 volt) batteries.**
- **Replace batteries with new ones of the same type when the display becomes dim.**

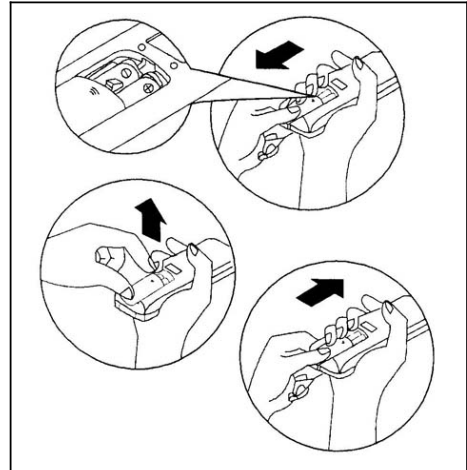

### **Using the Remote Controller**

- To operate the air conditioner, aim the remote controller at the receiver window.
- The remote control will operate the air conditioner at a distance up to 23 feet when pointed at the receiver window.

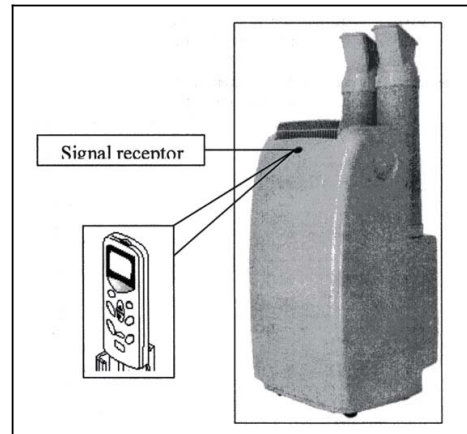

# Operating Instructions

## Operating modes

### MODE Selection

Each time the **MODE** button is pressed, unit's operating mode is changed in sequence:

**UNIT:** Smart → Cooling → Dry → Fan only

**REMOTE:** Cooling → Dry → Fan only

### FAN Selection

Each time **FAN** button is pressed, the fan speed is changed in sequence:

Auto → High → Low

**Note:**

- In "FAN" only mode, only High and Low fan speeds are available.
- In "DRY" mode, airflow is set at "Low". "FAN" button is ineffective in this mode.

### Temperature Setting

▲ Each press raises the temperature setting by 1°C (2°F).

▼ Each press lowers the temperature setting by 1°C (2°F).

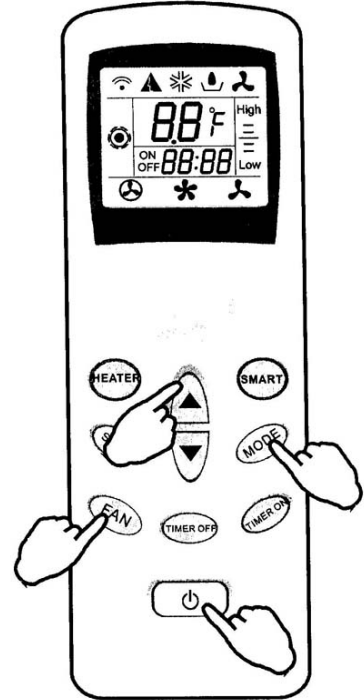

### Temperature Range

Temperature Range	
COOLING	18°C (64°F) ~ 32°C (90°F)
DRY	Room temperature ± 2°C (4°F)
FAN ONLY	Unable to set

### Power ON

Press  button. Once the unit receives the signal, the RUN indicator on the air conditioner will light up.

**HEATER (SUPER), SMART, DRY, TIMER ON and TIMER OFF operating modes will be specified in the following pages.**

- When changing modes during operation, allow 3 minutes for compressor to kick on.
- Wait 3 minutes before restarting the unit after powering off.

## COOLING mode

To lower the room's ambient temperature, operate the unit as follows:

1. Press **MODE** button to select COOLING mode.
2. Press **FAN** button to select desired fan speed.
3. Press the temperature **▲** or **▼** button to set desired temperature.

NOTE:

- The above settings can also be done while unit is powered OFF. Once you complete the above steps, press the POWER button and unit will start in COOLING mode.
- You can adjust the louver direction by pressing the SWING button. Press once to swing and press again to stop. (Press and hold the FAN button on the control panel for swing)
- Unit will memorize your last setting for Cool when powered off or switched back from other modes. Will return to default if unplugged.
- Once the room temperature reaches the set temperature, the compressor will stop and fan will continue to run.

**Unit operates  $\pm 1^{\circ}\text{C}$  ( $2^{\circ}\text{F}$ ) of set temperature.**

When operating in COOLING mode, compressor continues to run until ambient temperature has reached  $1^{\circ}\text{C}$  ( $2^{\circ}\text{F}$ ) below the set temperature. Compressor will then stop and unit will run in FAN mode. Once unit detects the ambient temperature has rise  $1^{\circ}\text{C}$  ( $2^{\circ}\text{F}$ ) above set temperature, compressor will resume.

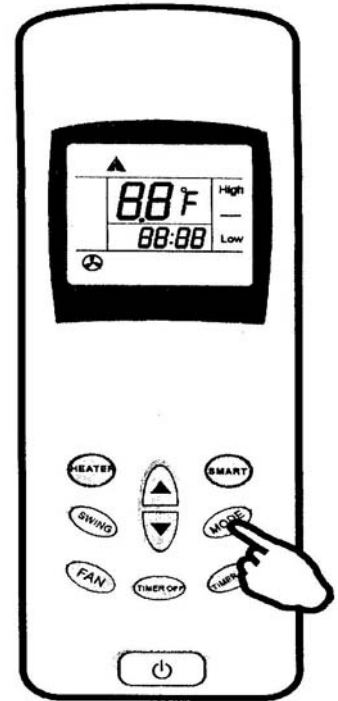

For example, your set temperature is  $70^{\circ}\text{F}$ . Compressor shuts off (and unit switches to FAN) at  $68^{\circ}\text{F}$  and resumes cooling at  $72^{\circ}\text{F}$ .

**AUTO FAN speed selected in COOLING mode:**

- When initial ambient temperature is higher than set temperature = HIGH Fan speed.
- When ambient temperature falls below the set temperature = LOW fan speed.
- When ambient temperature rise  $3^{\circ}\text{C}$  ( $6^{\circ}\text{F}$ ) above set temperature = HIGH fan speed.

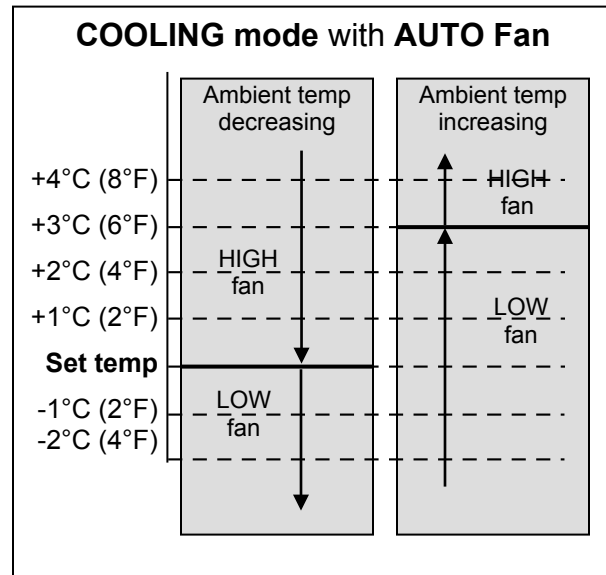
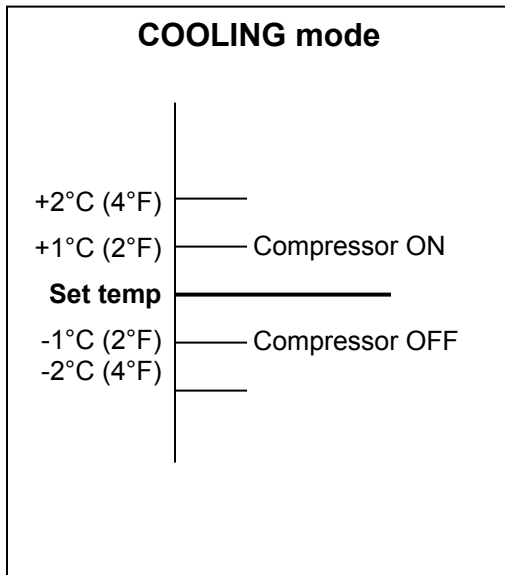

## **DRY mode**

To use the unit as a dehumidifier (remove moisture), operate the unit as follows:

- Press **MODE** button to select DRY mode.
- You can also select DRY mode while unit is powered off. Once DRY is selected, press the **POWER** button and unit will start in DRY mode.
- Adjust the louver direction, by pressing **SWING** button, if desired.

When unit is first initiated in DRY mode, as the compressor kicks on, unit will run in COOL mode, with settings at 18°C (64°F) for 3 minutes. This allows the unit to determine the ambient temperature. After 3 minutes, unit will automatically set the target temperature to be 1.5°C (3°F) below ambient. You cannot change the set temperature and fan speed in DRY mode.

### **NOTE:**

- ***DRY mode cannot be used to cool the room.***
- ***Requires only air exhaust hose to be installed. (Do not install the air intake hose).***
- ***In DRY mode, fan speed is pre-set at Low and cannot be changed. The FAN button is invalid in this mode.***

### **Delay Protection**

If you select COOLING or DRY mode while unit is running in another mode, the compressor will be delay-protected. Wait for 3 ~ 5 minute and unit will resume operation. Do not press any button during the wait time or unit will re-count the delay-protection time.

## SMART mode

Press the **SMART** button to enter smart mode (fuzzy logic operation). In this mode, the temperature is automatically set based on the room's ambient temperature.

If unit is OFF, pressing the SMART button will turn the unit on and operate in SMART mode.

\* There is no SMART button on the control panel. To select SMART from the control panel, press MODE button: Smart → Cooling → Dry → Fan only

**Unit will automatically determine the operating mode (COOL or DRY) when SMART mode is selected:**

Ambient temperature	Operating mode	Target temperature
26°C (79°F) or below	DRY	1.5°C (3°F) lower than ambient temperature, after 3 minutes.
Over 26°C (79°F)	COOLING	26°C (79°F)

- FAN speed can be changed if unit runs in SMART & COOL mode. Press FAN button to change in turn: Auto – High – Low.
- FAN speed cannot be changed if unit runs in SMART & DRY mode. The LCD displays as in image on the right, but in fact, the fan speed is preset and cannot be changed.

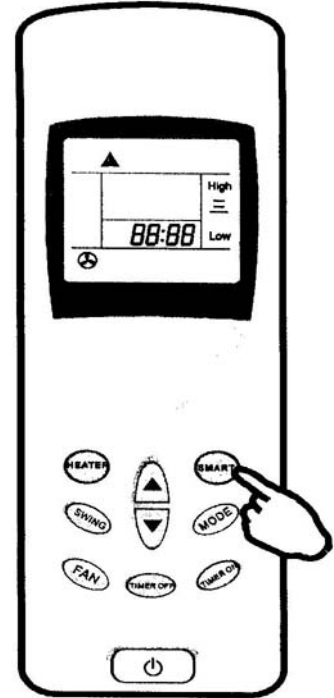

**SMART button is ineffective in SUPER mode.**

**Note: Temperature, airflow and direction are controlled automatically in SMART mode. However, you can choose to increase or decrease the temperature by up to 2°C (4°F).**

A increase or decrease up to 2°C (4°F) can be set in SMART mode				
You feel	Press	Adjustment procedure		
<b>Slightly warm</b> Decrease the temperature up to 2°C (4°F)	▼	A	Press once to lower the set temp by 1°C (2°F)	High Low
		B	Press twice to lower the set temp by 2°C (4°F)	High Low
<b>Slightly chill</b> Increase the temperature up to 2°C (4°F)	▲	A	Press once to raise the set temp by 1°C (2°F)	High Low
		B	Press once to raise the set temp by 2°C (4°F)	High Low
Uncomfortable due to air flow volume	FAN	Changes the FAN speed: Auto – High – Low (only applicable in SMART & COOL mode)		
Uncomfortable due to air flow direction	SWING	Press once to swing, press again for fixed airflow direction. <b>Note: There is no SWING button on the control panel. To activate or deactivate swing from the control panel, press and hold FAN button for 3 seconds</b>		

## Timer-ON and Timer-OFF settings

Timer-ON and Timer-OFF are convenient features for those who would like the unit to start and stop after a certain time. you can set the unit to turn ON After 5-hours. When you return, your home will have achieved a comfortable temperature. Or, before going to bed, you can set timer-OFF to have the unit turn off after so much time.

### **Timer-ON setting**

1. Press the TIMER-ON button once. You should see the ON indicator flash for 0.5 seconds and the time displaying 12:00.



2. Press the ▲ or ▼ button to increase or decrease your set time. Each press is an increment of 10 minutes. Press and hold down the buttons to speed up the process.
3. The set time clock is in 24-hours format. Maximum timer setting is within 24 hours.
4. Once the set time is achieved, press TIMER-ON button again.

### **To cancel Timer-On setting**

- Press and hold the TIMER-ON button for 3 seconds.

### **Timer-OFF setting**

- Follow the instructions as Timer-On setting, but use TIMER-OFF button.

***Once the time for Timer-ON or OFF is set, the unit will memorize the set time (unless power is disconnected). If you wish to set Timer-ON or OFF for the same time in a future day, simply press the Timer-ON or Timer-OFF button twice. If unit is unplugged, Timer settings will return to default.***

### **Adjusting real time (setting the clock)**

- Real time can be adjusted while unit is off or running (in any mode).
- Press TIMER-ON and TIMER-OFF buttons together.
- Clock will flash for 0.5 seconds and display 12:00.
- Adjust the real time by pressing the ▲ or ▼ button. Each press is in increment of 1 minute. Press and hold the ▲ or ▼ button and time will adjust in increments of 10 minutes.

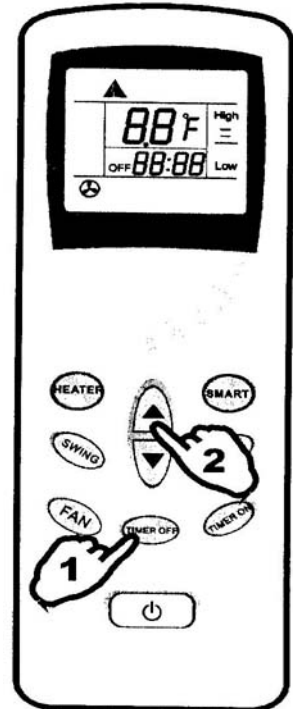
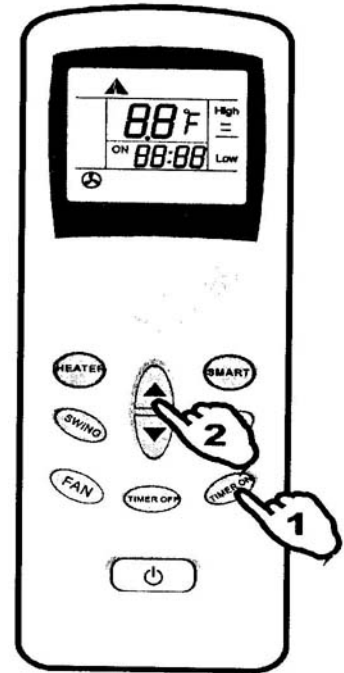



## SUPER mode

### **SUPER mode (applicable for Cooling only models)**

- SUPER mode is used to start or stop fast cooling.
- Press SUPER and unit will operate at high fan speed and automatically changing the current set temperature to 18°C (64°F).
- SUPER mode can be entered while unit is in operation or off.
- You can adjust airflow direction and set timer in SUPER mode.
- To escape from SUPER mode, press any of the following buttons: SUPER, MODE, FAN, POWER or temperature ▲ or ▼ buttons. Display will return to the original setting/mode.

**Note:**

- **SMART button is not applicable in SUPER mode.**
- **Unit will continue to run in SUPER mode (high fan at 18°C/64°F) until you press any of the buttons mentioned above.**
- **SUPER mode does not exist for models with Heater.**

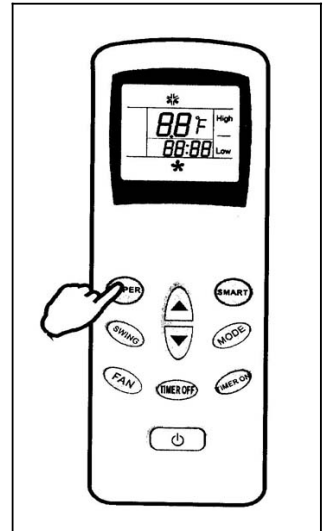

## HEATER mode

### **HEATER mode (for heating model only)**

- Press HEATER button to engage unit in Heater mode.
- If unit is off, pressing the HEATER button will turn unit on and operate in Heater mode.
- Press FAN button to change fan speed: High – Low.
- Timer-ON or Timer-OFF can be set in heating mode.
- To escape from HEATER mode, press the HEATER button again. Unit will engage in fan only mode.

**Note:**

- **HEATER can be selected while unit is running in other modes.**
- **Temperature cannot be set in HEAT mode.**
- **Temperature ▲ and ▼ buttons are invalid in Heater mode.**

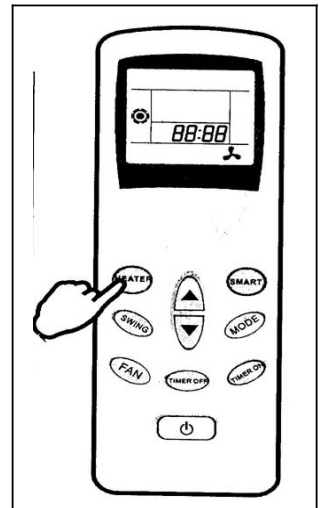

## Protection Features

### Operating Conditions and Protection Features

**The protective device may trip and stop the unit in the following cases:**

Mode	Situation	Reason	Action
COOLING	When outdoor temperature is over 43°C (109°F)	Compressor overheat	Remove air intake hose and use unit as single hose
	When ambient temperature is below 18°C (64°F)	Cooling coils freezing	Compressor will not work below 18°C (64°F)
DRY	When ambient temperature is below 18°C (64°F)	Cooling coils freezing	Compressor will not work below 18°C (64°F)

**The protective device will also engage in the following cases:**

- Restarting the unit immediately after operation stops or changing mode during operation. Please wait 3 ~ 5 minutes.
- Turning on the unit immediately after connecting to power source. There may be a 20 seconds delay.

#### NOTE:

- *If the air conditioner is running in COOLING or DRY mode with an open door or window for a long period of time when relative humidity is above 80%, dew may collect and drip from the outlet.*
- **Once unit is unplugged, all setting will return to default, including Timer-ON and Timer-OFF settings.**

### Water Drainage

In COOLING and DRY operations, water is condensed as air passes through. This unit is equipped with **Self-Evaporating Technology**, where most of the water is recycled and evaporated through the exhaust hose. In humid conditions, however, when water condenses faster than the unit can recycle, the excess water will collect within an inner water reservoir. When the water reservoir becomes full, the Water Full indicator will flash (red light) and unit will stop. At this time, you will need to drain the water reservoir before continuing operation:

1. Turn unit off and unplug from power source.
2. Move the appliance to a suitable place for water drainage. Push gently on the side to prevent water spilling.
3. Pull out the rubber plug and allow water to drain out.
4. Re-inserted the rubber plug when done. Make sure the rubber plug is replaced, or water will leak.
5. If the unit is placed in a position allowing water drainage, connect the drain hose to the spout for water drainage.

## Maintenance

### Cleaning the AC unit

1. Turn off unit and remove power source.

Turn appliance off before disconnecting from power supply.

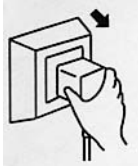

2. Wipe housing with a soft, dry cloth.



3. Never use volatile substance such as gasoline or polishing powder to clean the appliance.



4. Never spray water directly onto the main unit.

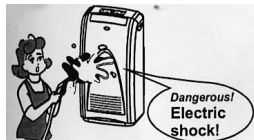

### Cleaning the Air Filter

It is necessary to clean the air filter after approximately 100 hours of usage, or whenever the filters appear dirty.

1. Turn off unit. Remove the air filter by pulling the frame upwards.

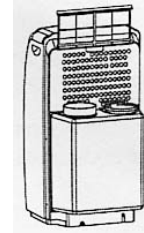

2. Clean the air filter
  - Tap the filter lightly to remove loose particles.
  - Vacuum the filter.
  - If extremely dirty, wash the filter in lukewarm water and allow to dry completely in a shaded place before replacing.



3. Clean the air filter once every two weeks if the unit is operating in an extremely dusty environment.





### Preparing the unit for storage

If the unit will not be used for a long period of time, follow the below instructions for unit storage:

1. Drain water from the reservoir and replace rubber plug.
2. Connect to power source and run unit in FAN only mode for 4 ~ 6 hours on a sunny day. This will allow the unit's interior to dry and prevent molding.
3. Turn unit off and remove power source. Remove batteries from the remote and store in a safe place.
4. Clean the air filters and replace.
5. Remove the two air hoses and store them properly. Cover the hose openings on the unit.
6. Place unit back in original packaging (if available).
7. Store in a cool, dry place.

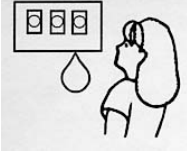
## Troubleshooting

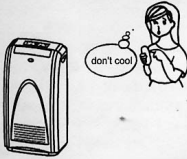
*The following cases may not always be a malfunction. Please check the following suggestions before asking for service.*

Problem	Possible cause and resolution
Unit does not run 	<ul style="list-style-type: none"> <li>• Check if the protector trip or fuse is blown.</li> <li>• Please wait 3~5 minutes before restarting – delay-protection may be preventing the unit to run.</li> <li>• Check if batteries in the remote controller need replacing.</li> <li>• Check if the plug is securely plugged in.</li> </ul>
Compressor runs for short period of time and stops. 	<ul style="list-style-type: none"> <li>• Check if set temperature is too close to ambient temperature. If so, lower the set temperature.</li> <li>• The air outlet may be blocked by obstacles, remove obstacles.</li> <li>• Check if the air filters are dirty.</li> <li>• Check if outdoor temperature is too high.</li> </ul>
Unit runs but not cooling 	<ul style="list-style-type: none"> <li>• There may be doors or windows open.</li> <li>• There may be other appliances creating a heat source in the same room (heater, lamp, computer, etc.).</li> <li>• Air filter is dirty, please clean.</li> <li>• Air outlet or inlet is blocked.</li> <li>• Set temperature is higher than ambient temperature.</li> </ul>
Water leaks while unit is being moved 	<ul style="list-style-type: none"> <li>• Inner water reservoir is open-top. Move the unit by pushing gently and evenly on the side.</li> <li>• If possible, drain water before moving.</li> </ul>
Unit does not run and red light is flashing 	<ul style="list-style-type: none"> <li>• Water reservoir is full. Remove rubber plug and drain water.</li> </ul>

## Specifications

	WA-9040DE	WA-9040DH	WA-1140DE	WA-1340DE	WA-1340DH
Cooling capacity (BTU/hr)	9,000	9,000	11,000	13,000	13,000
Heating capacity (BTU/hr)	-	4,100	-	-	4,100
Power supply	115V / 60Hz	115V / 60Hz	115V / 60Hz	115V / 60Hz	115V / 60Hz
Amperage	8.5 A	8.5 A	10.9 A	12 A	12 A
Wattage	Cooling	977	977	1253	1380
	Heating	-	1246	-	-
Recommended room size	250 sq. ft.	250 sq. ft.	350 sq. ft.	420 sq. ft.	420 sq. ft.
Humidity removal capacity (pints/day)	47	47	51	55	55
Air flow volume (CFM)	176	176	176	235	235
Noise level (dB) High / Low	49 / 43	49 / 43	49 / 43	52 / 45	52 / 45
Compressor type	Rotary	Rotary	Rotary	Rotary	Rotary
Refrigerant type / Capacity	R22 / 1.4 lb	R22 / 1.4 lb	R22 / 1.45 lb	R22 / 1.4 lb	R22 / 1.4 lb
Fan speed	3 (Auto – High – Low)				
Thermostat settings	64°F ~ 90°F				
Operating temp.	64°F ~ 110°F				
Timer-ON and Timer-OFF	Up to 24 hours				
Unit dimension (W x D x H)	17.8 x 18.5 x 33.33 in.			17.8 x 19.7 x 32.3 in.	
Carton dimension (W x D x H)	20.3 x 23 x 35.1 in.			20.3 x 26 x 35.1 in.	
Net weight	82 lbs			86 lbs	
Gross weight	88 lbs			93 lbs	

\* Data may vary for technical reasons, please refer to the rating label.

- Please read this manual thoroughly before installing and using your new portable air conditioner.
- Un-insulated rooms such as sunrooms, garages or attics should be less than the suggested sq. ft.
- The following may effect the cooling efficiency of the unit in reaching your set temperature: outside temperature, room size, ceiling height, room insulation, number of people in the room, direct sunlight and sources of heat.
- Measuring conditions for above is:  
 COOLING – RT 80.6°F, RH 60%  
 HEATING – RT 68°F, RH 60W  
 (without hose connection)  
 RT = room temperature  
 RH = room humidity



## Portable Air Conditioner

### Your Guarantee

**If this product is found to be faulty as a result of faulty materials or workmanship within one year from date of purchase, it will be repaired free of charge.**

This guarantee is subject to the following terms:

- Sunpentown must be notified of the fault.
- Proof of purchase must be presented to Sunpentown's nominated representative.
- The warranty will be void if the product is modified, misused or repaired by an unauthorized person.
- The warranty after repair will not be extended beyond the original one-year period.
- All replacement parts will be new or reconditioned.
- Parts, which are replaced, become the property of Sunpentown.
- The warranty applies for the use of the product in the USA only.

#### **What is NOT COVERED:**

- Warranty does not include freight charges.
- Incidental or consequential damage caused by possible defects with this product.
- Damage to product caused by improper power supply voltage, accident, fire, floods or acts of nature.
- Failure of product resulting from unauthorized modifications to the product.
- Improper installation or failure to perform the necessary maintenance.

This GUARANTEE is in addition to your Statutory Rights

**SUNPENTOWN INTERNATIONAL INC.**  
**21415 Baker Parkway, City of Industry, CA 91789-5236**  
**Tel: 909-468-5288 · Fax: 909-468-5279**  
**service@sunpentown.com**  
**www.spt-usa.com**