

TOP VIEW
(DUCT EXIT SHOWN IN TOP LOCATION)

LYNX 36 IN. OUTDOOR VENT HOOD
MODEL LOH36
W/ DIMENSIONS

NOTE: THIS PRODUCT USES A REMOVABLE PLATE WHICH LOCATES THE DUCT EXIT HOLE AND ELECTRICAL EXIT HOLES EITHER AT THE TOP OF THE HOOD OR AT THE REAR OF THE HOOD.

THE REAR DRAWING VIEWS SHOW EACH LOCATION. THE TOP VIEW SHOWS THESE HOLES IN THE TOP LOCATION.

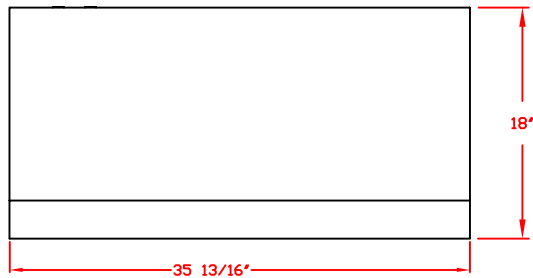
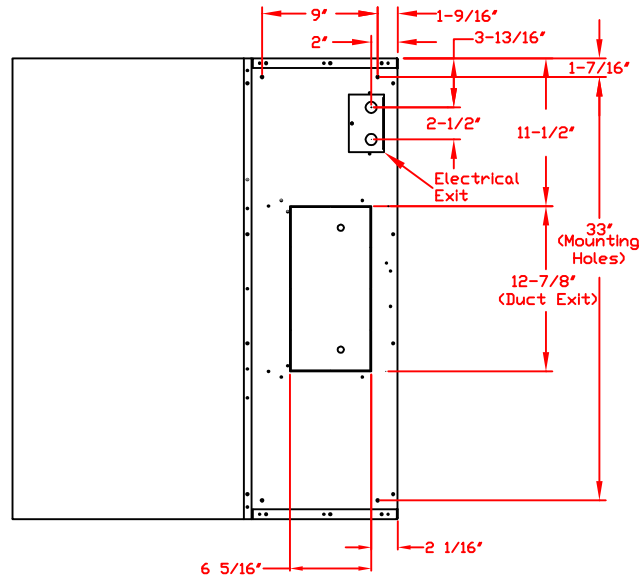

FRONT VIEW

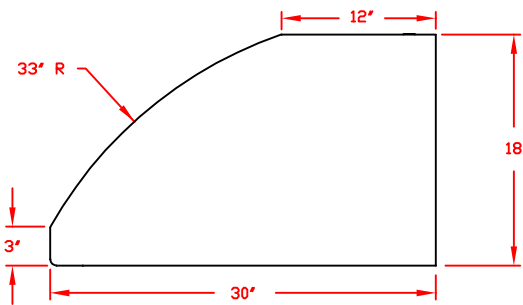

SIDE VIEW

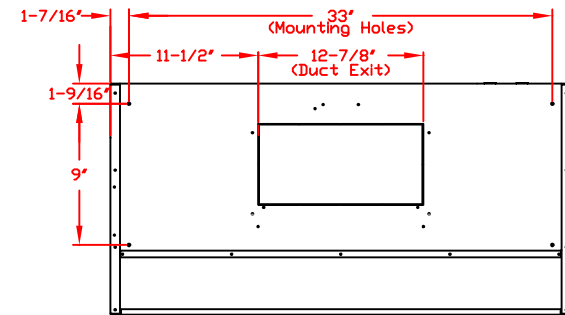

REAR VIEW
(DUCT EXIT SHOWN IN BACK LOCATION)