

**Burner Systems:**

P45- \*\* (P)A

P45- \*\* -17(P)

\*\* Sizes:

(18, 24, 30)

Regulated burner system for use with propane or natural gas

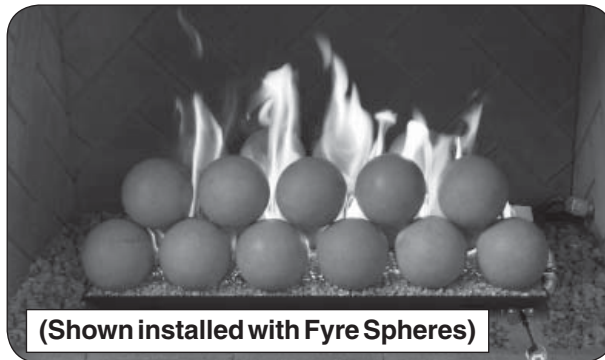

(Shown installed with Fyre Spheres)

**DESIGN CERTIFIED**  
to  
**Vented Decorative Appliance**  
ANSI Z21.60-2012  
CSA 2.26-2012

**FOR INSTALLATION IN  
SOLID-FUEL BURNING  
FIREPLACES\***

**P45 VENTED BURNER SYSTEMS**

**WARNING**

If the information in this manual is not followed exactly, a fire or explosion may result, causing property damage, personal injury, or loss of life.

Do not store or use gasoline or other flammable vapors and liquids in the vicinity of this or any other appliance.

**WHAT TO DO IF YOU SMELL GAS:**

- Open a window.
- Do not try to light any appliance.
- Do not touch any electrical switch; do not use any phone in the building.
- Immediately call the gas supplier from a neighbor's phone. Follow gas supplier's instructions.
- If you cannot reach the gas supplier, call the fire department.

Installation and service must be performed by a qualified professional service technician, service agency, or the gas supplier.

This appliance is only for use with the type of gas indicated on the rating plate.

**IMPORTANT: READ THESE INSTRUCTIONS CAREFULLY BEFORE STARTING INSTALLATION OF THE UNIT.**

The Real Fyre burner system is to be installed only in a solid-fuel burning fireplace with a working flue and constructed of noncombustible material. The installation, including provisions for combustion and ventilation air must conform with the *National Fuel Gas Code, ANSI Z223.1/NFPA 54*, or the *CSA B149.1, Natural Gas and Propane Installation Code*, and applicable local building codes.

A damper clamp is included to maintain the minimum permanent vent opening and to prevent full closure of the damper blade. **The chimney damper MUST be fully opened when burning the unit. The unit is designed to burn with yellow flames; thus adequate ventilation is absolutely necessary.**

To comply with certification, listings, and building code acceptances, and for safe operation and proper performance of this burner system, use ONLY Peterson parts and accessories. Use of other controls, parts, and accessories that are not designed for use with Real Fyre burner systems is prohibited and will void all warranties, certifications, listings, and building code approvals, and may cause property damage, personal injury, or loss of life.

**\*Note:** Solid-fuels shall not be burned in a fireplace where a decorative appliance is installed.



**INSTALLER:**  
Leave this manual with the appliance.  
**CONSUMER:**  
Retain this manual for future reference.



**Systèmes De Brûleur:**

**P45- \*\* (P)A  
 P45- \*\* -17(P)**

**\*\* Tailles:  
 (18, 24, 30)**

**Système de brûleur  
 réglementé l'usage du  
 propane ou du gaz naturel**

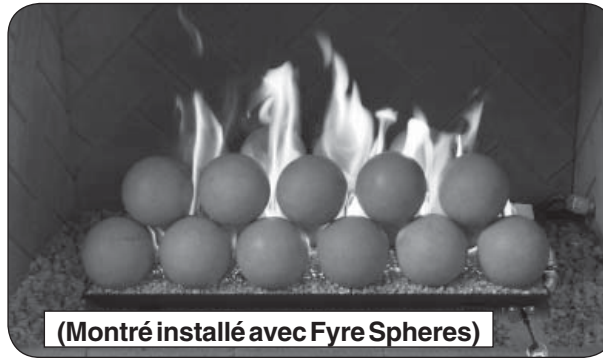

**CONCEPTION CERTIFIÉE  
 à  
 Vented Decorative Appliance  
 ANSI Z21.60-2012  
 CSA 2.26-2012**

**POUR L'INSTALLATION DANS  
 LE COMBUSTIBLE SOLIDE DE  
 BRÛLANT FIREPLACES\***

**P45 SYSTÈMES DE BRÛLEURS VENTED**

**AVERTISSEMENT**

Si l'information en ce manuel n'est pas suivie exactement, une incendie ou une explosion peut résulter, entraînant des dégâts matériels, des blessures, ou la perte de la vie.

Ne stockez pas ou n'employez pas l'essence ou d'autres vapeurs et liquides inflammables à proximité de ceci ou d'aucun autre appareil.

**CE QUI À FAIRE SI VOUS SENTEZ LE GAZ:**

- Ouvrez une fenêtre.
- N'essayez pas de n'allumer aucun appareil.
- Ne touchez aucun commutateur électrique; n'utilisez aucun téléphone dans le bâtiment.
- Appelez immédiatement le fournisseur de gaz du téléphone du voisin. Suivez les instructions du fournisseur de gaz.
- Si vous ne pouvez pas atteindre le fournisseur de gaz, appelez le département de feu.

Installation et entretien doivent être effectués par un technicien professionnel qualifié de service, un organisme de service ou le fournisseur de gaz.

Cet appareil sert seulement avec le type de gaz indiqué de la plaque de contrôle.

**INSTALLATEUR :**

**Laissez ce manuel avec l'appareil.**

**CONSOMMATEUR:**

**Maintenez ce manuel pour la future référence.**



**IMPORTANT: LISEZ CES INSTRUCTIONS  
 SOIGNEUSEMENT AVANT DE  
 COMMENCER L'INSTALLATION DE  
 L'UNITÉ.**

Le Real Fyre système de brûleur doit être installé seulement dans une cheminée brûlante de combustible solide avec une conduite de cheminée fonctionnante et être construit avec du matériel non-combustible. L'installation, y compris des dispositions pour l'air de combustion et de ventilation doit se conformer au code national de gaz de carburant, la norme ANSI Z223.1/ NFPA 54, ou le CSA B149.1, code d'installation de gaz naturel et de propane, et codes du bâtiment locaux applicables.

Une bride plus humide est incluse pour maintenir l'ouverture permanente minimum de passage et pour empêcher la pleine fermeture de la lame plus humide. **L'amortisseur de cheminée DOIT être entièrement ouvert en brûlant l'unité. L'unité est conçue pour brûler avec les flammes jaunes; ainsi à ventilation proportionnée est absolument nécessaire.**

Pour se conformer à la certification, les listes, et les acceptations de codes du bâtiment, et pour l'exploitation sûre et l'exécution appropriée de ce système de brûleur, utilisent SEULEMENT des pièces et des accessoires de Peterson. L'utilisation d'autres commandes, pièces, et accessoires qui ne sont pas conçus pour l'usage avec de Real Fyre systèmes de brûleur est interdite et videra toutes les garanties, certifications, listes, et approbations de codes du bâtiment, et peut causer des dégâts matériels, le dommage corporel, ou des pertes humaines.

**\*Note:** des Plein-carburants ne seront pas brûlés dans une cheminée où un appareil décoratif est installé.

# TABLE OF CONTENTS

## GETTING STARTED

IMPORTANT PRE-INSTALLATION AND FIREPLACE SAFETY INFORMATION .....	5
FIREPLACE OPERATING SAFETY INFORMATION .....	7
SPECIFICATIONS .....	8
DAMPER CLAMP INSTRUCTIONS .....	11
BURNER REPLACEMENT PARTS LIST - MANUAL PILOT (A) SERIES .....	12
BURNER REPLACEMENT PARTS LIST - 17 SERIES .....	13

## INSTALLATION

INSTALLATION .....	14
<i>BURNER INSTALLATION</i> .....	14
<i>LIGHTING TEST</i> .....	14
INSTALLATION - LOG SET AND FYRE SPHERE MODELS .....	15
<i>LAVA GRANULES/COALS (optional)</i> .....	15
<i>SAND AND/OR VERMICULITE PLACEMENT</i> .....	15
<i>LOG SET PLACEMENT</i> .....	16
<i>FYRE SPHERES PLACEMENT</i> .....	17
INSTALLATION - GLASS MEDIA MODELS .....	20
<i>SAND / VERMICULITE PLACEMENT</i> .....	20
<i>GLASS / GEMS PLACEMENT</i> .....	21
<i>DECORATIVE MEDIA ON FIREPLACE FLOOR (optional)</i> .....	21
INSTALLING/REPLACING BATTERIES (IF APPLICABLE) .....	22
<i>REMOTE TRANSMITTER BATTERY</i> .....	22
<i>REMOTE RECEIVER BATTERIES</i> .....	22
OPTIONAL ACCESSORIES .....	22

## USE, CARE, & SERVICE

LIGHTING INSTRUCTIONS - MANUAL PILOT (A) SERIES .....	23
<i>FOR YOUR SAFETY, READ BEFORE LIGHTING</i> .....	23
<i>LIGHTING THE PILOT</i> .....	23
<i>LIGHTING THE BURNER</i> .....	25
<i>SHUTTING DOWN</i> .....	25
<i>PILOT BURNER CHECK/ADJUSTMENT</i> .....	25
LIGHTING INSTRUCTIONS - 17 SERIES .....	27
<i>FOR YOUR SAFETY, READ BEFORE LIGHTING</i> .....	27
<i>LIGHTING THE PILOT</i> .....	27
<i>REMOTE LIGHTING</i> .....	27
<i>MANUAL LIGHTING</i> .....	29
<i>SHUTTING DOWN</i> .....	31
<i>PILOT BURNER CHECK/ADJUSTMENT</i> .....	31
REMOTE OPERATING INSTRUCTIONS - 17 SERIES .....	31
<i>ORIENTATION</i> .....	31
<i>FLAME HEIGHT</i> .....	31
CLEANING AND SERVICING .....	33
<i>SYNCING THE REMOTE SYSTEM (if applicable)</i> .....	34
FLAME DESCRIPTION .....	34
TROUBLESHOOTING .....	35
NOTES PAGE .....	37
WARRANTY .....	38

## L'INFORMATION DE SÛRETÉ IMPORTANTE DE PRÉINSTALLATION ET DE CHEMINÉE

**ATTENTION:** L'installation et la réparation doivent être faites par un NFI certifié ou tout autre installateur professionnel qualifié.

**Installateur:** Lisez soigneusement ces instructions avant d'installer ce système de brûleur à gaz. Soyez sûr que vous comprenez tous les mesures de sécurité et avertissements contenus en ce manuel.

- A. FAITES ATTENTION: Sinon installé, entretenu, et utilisé correctement par ces instructions, ce produit peut causer le dommage corporel, les dégâts matériels, ou les pertes humaines sérieux.**
- B. AVERTISSEMENT:** Avant l'installation dans une cheminée plein-carburant-brûlante, la conduite de cheminée, l'amortisseur, et le foyer de cheminée doivent ÊTRE COMPLÈTEMENT NETTOYÉS de la suie, de la créosote, des cendres, et de la peinture lâche, et doivent être inspectés par un décapant qualifié de cheminée. Quelques cheminées plus anciennes peuvent ont besoin de réparation avant d'installer cet appareil.
- C.** Cet appareil sert seulement avec le type de gaz indiqué de la plaque de contrôle. Cet appareil n'est pas CONVERTIBLE de CHAMP pour l'usage avec d'autres gaz.  
VÉRIFIEZ LE TYPE de GAZ (normal ou propane) : La fourniture de gaz doit être identique qu'indiquée de votre plaque de contrôle de système de brûleur. Si la fourniture de gaz est différente, **N'INSTALLEZ PAS**. Contactez votre revendeur pour l'aide immédiate.
- D.** LA PRESSION DE GAZ INSUFFISANTE GARDERA LE PILOTE DU FONCTIONNEMENT CORRECTEMENT (SI ÉQUIPÉ). N'EMPLOYEZ PAS SI LA PRESSION DE GAZ EST INFÉRIEURE À LA CONDITION MINIMUM.
- E.** L'admission minimum gaz-fournissent la pression aux fins de l'ajustement d'entrée est 5" ; colonne d'eau (w.c.) sur le gaz naturel et le 11" ; w.c. sur le gaz de propane. La pression de gaz insuffisante affectera l'opération appropriée du pilote (si équipé). N'installez pas cet appareil à gaz si la pression minimum n'est pas disponible. L'admission maximum gaz-fournissent la pression est 10.5" ; w.c. sur le gaz naturel et le 13" ; w.c. sur le gaz de propane. La source de propane doit être réglée. **(Ne branchez pas cet appareil directement à un réservoir de gaz propane non réglementée - cela peut provoquer une explosion.) Ne branchez pas cet appareil à une bouteille de gaz propane portable.**
- F.** **Le système sifflant de gaz doit être classé pour fournir la pression d'admission minimum au débit maximum (BTU/hr).** La perte de pression anormale se produira si la pipe est trop petite, ou la course est trop longue. La pipe de fourniture de gaz doit être 1/2" ; diamètre intérieur minimum. Si la ligne de gaz est plus longue que 20' ; une ligne de plus grand diamètre peut être nécessaire. Reportez-vous aux directives NFPA 54 pour plus de détails.
- G.** Les estimations d'entrée montrées en Btu par heure sont pour des altitudes jusqu'à 2.000 pi. Pour des altitudes au-dessus de 2.000 pi, référez-vous au code national de gaz de carburant ou entrez en contact avec le fabricant avant d'installer ce produit.
- H.** Cet appareil à gaz et son clapet à gaz principal doivent être disconnected du gaz-fournissent le système sifflant pendant tout vérificateur de pression de ce système aux pressions d'essai au-dessus de 1/2 psig.
- I.** Cet appareil à gaz doit être isolé dans gaz-fournissent le système sifflant en fermant le robinet d'isolement d'équipement relié au gaz-fournissent la ligne pendant tout vérificateur de pression du gaz-fournissent le système sifflant aux pressions d'essai égales à ou moins d'à 1/2 psig.
- J.** **Pour installer l'appareil à gaz dans votre foyer, le foyer doit satisfaire aux exigences minimales de taille (voir le tableau des spécifications du produit dans la section SPÉCIFICATIONS).**
- K.** Cet appareil peut être installé dans un marché des accessoires, maison (mobile) de manière permanente située et manufacturée, où non interdit par des codes locaux. L'installation des appareils a conçu pour la maison manufacturée (États-Unis seulement) ou installation de caravane résidentielle doit se conformer au CAN/CSA standard Z240 MH, logement mobile, au Canada, ou à la construction et au standard de sécurité à la maison manufacturés, intitulent 24 CFR, la partie 3280, aux Etats-Unis, ou quand une telle norme ne s'applique pas, à ANSI/NCSBCS A225.1/NFPA 501A, installations à la maison manufacturées standard.
- L.** **NE PAS installer ce système de brûleur si le foyer de la cheminée est en retrait.** Le plancher du foyer doit être au même niveau ou plus élevé que l'ouverture de cheminée avant. Si les portes en verre sont utilisées: le plancher du foyer ne doit pas être bloqué par le cadre de la porte; le cadre doit avoir des ouvertures pour permettre la circulation de l'air frais. Voir la section SPÉCIFICATIONS pour plus de détails.
- M.** **LORS DE L'INSTALLATION AVEC VERRE MEDIA, PETERSON (REAL FYRE) VERRE OU GEMMES SONT LE SEUL VERRE MEDIA CERTIFIÉ À UTILISER DANS CE BRÛLEUR. NE PAS UTILISER TOUT AUTRE MEDIA EN VERRE.** Une installation correcte du verre / gemmes et le placement et l'installation de l'ensemble de brûleur approprié, sont indispensables pour un fonctionnement sûr de votre appareil. Des problèmes se produire si tous les éléments ne sont pas correctement installés.  
La quantité correcte de verre/de gemmes doit être employée sur votre système de brûleur pour qu'elle fonctionne correctement. Vous pouvez employer le verre/gemmes additionnels, ou des granules de lave pour couvrir le plancher de la cheminée. S'il vous plaît lire la section POSITIONNEMENT DE VERRE / GEMMES ensemble pour plus de détails.

## IMPORTANT PRE-INSTALLATION AND FIREPLACE SAFETY INFORMATION

**CAUTION:** Installation and repair must be done by an NFI Certified or other qualified professional installer.

**Installer:** Carefully read these instructions before installing this gas burner system. Be sure you understand all safety precautions and warnings contained in this manual.

**A. BE CAREFUL:** If not installed, serviced, and used correctly per these instructions, this product can cause serious personal injury, property damage, or loss of life.

**B. WARNING:** Before installing in a solid-fuel-burning fireplace, the chimney flue, damper, and firebox must be thoroughly CLEANED of soot, creosote, ashes, and loose paint, and must be inspected by a qualified chimney cleaner. Some older fireplaces may need repair prior to installing this appliance.

**C.** This appliance is only for use with the type of gas indicated on the rating plate. This appliance is **NOT FIELD CONVERTIBLE** for use with other gasses.

CHECK GAS TYPE (natural or L.P.): The gas supply must be the same as stated on your burner system rating plate. If gas supply is different, **DO NOT INSTALL**. Contact your dealer for immediate assistance.

**D. INSUFFICIENT GAS PRESSURE WILL KEEP THE PILOT (IF EQUIPPED) FROM OPERATING PROPERLY. DO NOT USE IF GAS PRESSURE IS LOWER THAN THE MINIMUM REQUIREMENT.**

**E.** The *minimum* inlet gas-supply pressure for purposes of input adjustment is **5"** water column (w.c.) on **natural gas** and **11"** w.c. on **L.P. gas**. Insufficient gas pressure will affect proper operation of the pilot (if equipped). Do not install this gas appliance if minimum pressure is not available. The *maximum* inlet gas-supply pressure is **10.5"** w.c. on natural gas and **13"** w.c. on L.P. gas. The L.P. source must be regulated. **(Do not connect this appliance directly to an unregulated L.P. gas tank - this can cause an explosion.) Do not connect this appliance to a portable L.P. gas cylinder.**

**F. The gas piping system must be sized to provide minimum inlet pressure at the maximum flow rate (BTU/hr).** Undue pressure loss will occur if the pipe is too small, or the run is too long. Gas supply pipe must be 1/2" minimum interior diameter. If the gas line is longer than 20', a larger diameter line may be necessary. Refer to the NFPA 54 guidelines for further details.

**G.** Input ratings shown in BTU per hour are for elevations up to 2,000 ft. For elevations above 2,000 ft., refer to the National Fuel Gas Code or contact manufacturer before installing this product.

**H.** This gas appliance and its main gas valve must be disconnected from the gas-supply piping system during any pressure testing of that system at test pressures in excess of 1/2 psig.

**I.** This gas appliance must be isolated from the gas-supply piping system by closing the equipment shutoff valve connected to the gas-supply line during any pressure testing of the gas-supply piping system at test pressures equal to or less than 1/2 psig.

**J. To install the gas appliance in your fireplace, the fireplace MUST meet the minimum size requirements (see product specifications table in SPECIFICATIONS section).**

**K.** This appliance may be installed in an aftermarket, permanently located, manufactured (mobile) home, where not prohibited by local codes. Installation of appliances designed for manufactured home (U.S. only) or mobile home installation must conform with the Standard *CAN/CSA Z240 MH, Mobile Housing*, in Canada, or with the *Manufactured Home Construction and Safety Standard, Title 24 CFR, Part 3280*, in the United States, or when such a standard is not applicable, *ANSI/NCSBCS A225.1/NFPA 501A, Manufactured Home Installations Standard*.

**L. DO NOT install this burner system if the fireplace hearth is recessed.** The fireplace floor must be at the same level as or higher than the fireplace front opening. If glass doors are used: the fireplace floor must not be blocked by the door frame; the frame must have openings to allow for fresh air circulation. See the SPECIFICATIONS section for details.

**M. WHEN INSTALLING WITH GLASS MEDIA, PETERSON (REAL FYRE) GLASS OR GEMS ARE THE ONLY GLASS MEDIA CERTIFIED TO BE USED IN THIS BURNER. DO NOT USE ANY OTHER GLASS MEDIA.** Correct installation of the glass/gems and proper placement and installation of the burner assembly, are imperative to safe operation of your appliance. Problems **WILL** occur if all items are not properly installed.

The correct amount of glass/gems **must** be used on your burner system for it to operate properly. You may use additional glass/gems, or lava granules to cover the floor of the fireplace. Please read the entire GLASS/GEMS PLACEMENT section for details.

## INFORMATIONS SUR LA SÉCURITÉ D'EXPLOITATION DE CHEMINÉE

- A. Adultes doivent être présents lors de cet appareil au gaz est en marche. Cette unité ne doit pas être laissé sans surveillance ou brûlure lorsque tout quelqu'un dort.
- B. Gardez le domaine du clair réglé de notation de gaz et libérez des matériaux combustibles, l'essence, et d'autres vapeurs et liquides inflammables.
- C. Ne pas utiliser cet appareil si une partie quelconque a été submergée. Appelez immédiatement un technicien de service qualifié pour inspecter l'appareil et pour remplacer toute pièce du système de contrôle et toute commande de gaz qui a été sous l'eau. Tentative d'opération peut entraîner un incendie ou une explosion entraînant des dommages matériels, des blessures ou des pertes de vie.
- D. **Una pantalla de la chimenea debe ser en el lugar cuando el sistema está quemando.** Las provisiones para el aire de combustión adecuado deben ser mantenidas. A menos que otras provisiones para el aire de combustión se proporcionen, la pantalla tendrá una abertura para la introducción de aire de combustión. El aire de combustión es adecuado cuando todas las llamas se encrespan en la chimenea y lejos de la pantalla. **Cuando se utiliza un recinto de cristal de la chimenea (puerta), deje las puertas completamente abiertas cuando el sistema es en funcionamiento.**
- E. Ne retirez pas les plaques signalétiques ou les étiquettes d'avertissement. Ceux-ci sont une composante de sécurité et d'identification intégrante de cet appareil.
- F. Assurez-vous de lire la section de nettoyage et l'entretien et la section de description de la flamme.

## FIREPLACE OPERATING SAFETY INFORMATION

- A. Adults shall be present when this gas appliance is operating. This unit shall not be left burning when unattended or while anyone is sleeping.
- B. Keep the area of the gas burner system clear and free from combustible materials, gasoline, and other flammable vapors and liquids.
- C. DO NOT use this appliance if any part has been underwater. Immediately call a qualified service technician to inspect the appliance and to replace any part of the control system and any gas control that has been underwater. Attempted operation may result in fire or explosion resulting in property damage, personal injury or loss of life.
- D. **A fireplace screen must be in place when the system is burning.** Provisions for adequate combustion air must be maintained. Unless other provisions for combustion air are provided, the screen shall have an opening(s) for introduction of combustion air. Combustion air is adequate when all flames curl into the fireplace and away from the screen. **When a glass fireplace enclosure (door) is used, leave the doors fully open when the system is in operation.**
- E. Do not remove the rating plates or the warning tags. These are an integral safety and identification component of this appliance.
- F. Be sure to read the CLEANING AND SERVICING and FLAME DESCRIPTION sections.

# SPECIFICATIONS

Real Fyre gas burner systems must be installed only in a wood burning fireplace with the minimum firebox dimensions and venting requirements met (see table on this page). This appliance is designed to burn with yellow flames; adequate ventilation is absolutely necessary.

## Product Specifications

Burner Model	Minimum Fireplace Size				BTU Rating	
	Width *		Depth ‡	Height	Nat. Gas	L.P. Gas
	Front	Rear †				
P45-18	25"	25"	16"	17"	43k	36k
P45-24	31"	31"	16"	17"	65k	55k
P45-30	37"	37"	16"	17"	84k	70k

\* These required widths allow for centering of the unit.

† Rear width is at corresponding depth.

‡ If an ash lip exists, the depth requirement begins inside of the lip (see Fig. 8-1 below).

**Table 1 - Product Specifications**

Specification	Value	Qty.
Remote transmitter battery type	12V battery	1
Remote receiver battery type	AA battery	4

**Table 2 - Technical Data (if applicable)**

## Fireplace Floor Requirement

**DO NOT** install this burner system if the fireplace hearth is recessed. The fireplace floor must be at the same level as or larger than the fireplace front opening. An ash lip or recess may not exceed  $\frac{3}{4}$ ". See Fig. 8-1 below.

**Note:** If glass doors are used: the fireplace floor must not be blocked by the door frame; the frame must have openings to allow for fresh air circulation.

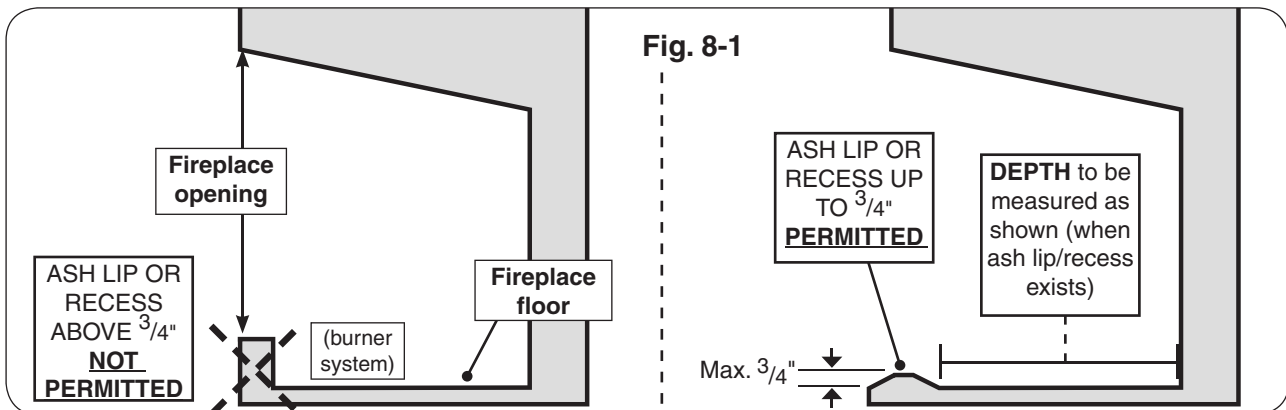



## SPECIFICATIONS (cont.)

Only the decorative media options listed below are approved for use with this product. Follow the recommendations for media amounts. All decorative media options are purchased separately; contact your local Real Fyre dealer when ordering.

### When using Fyre Spheres:

Model size	Correct Amount of Fyre Spheres	
	4" Spheres	5" Spheres
18"	19	14
24"	24	19
30"	34	24

**Table 3 - Fyre Sphere Amounts**

### When using glass media:

Model size	Correct Amount of Glass / Gems
18"	10 lbs
24"	15 lbs
30"	20 lbs

**Table 4 - Glass Amounts**

### When using a log set:

Optional log sets are available. Refer to the instructions included with the log set for complete details.

**17 SERIES WIRING DIAGRAM**

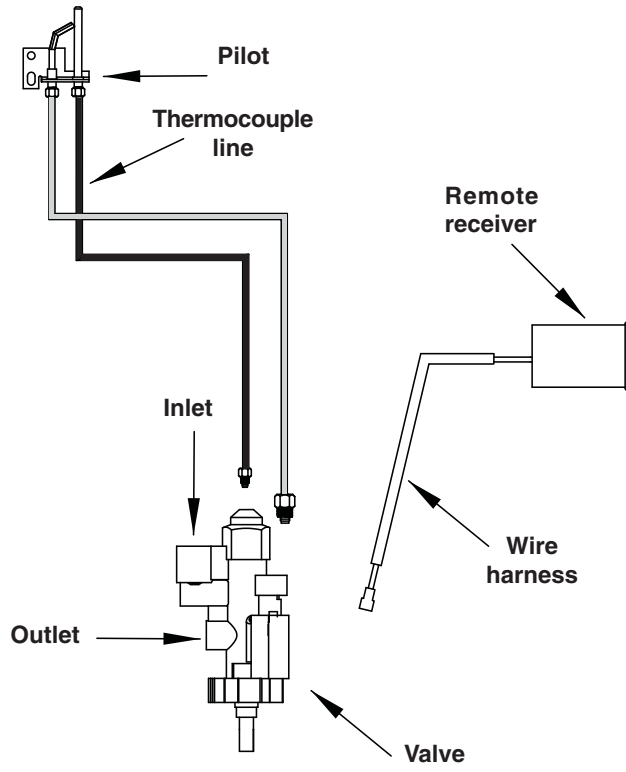

**Fig. 10-1**

# DAMPER CLAMP INSTRUCTIONS

The damper clamp with hex bolt (Fig. 11-1) is provided as a means to prevent full closure of the damper blade. The clamp is easily attached to most damper blades with pliers or a wrench, and must be permanently installed. The clamp is designed to prevent accidental closure of the damper when installed as illustrated (Fig. 11-2). Should the clamp not fit, or fail to provide the permanent vent opening listed in Table 5 below, have a permanent stop installed, remove the damper blade, or have the damper cut to provide the minimum permanent opening required.

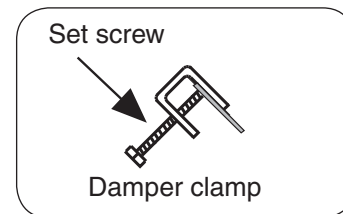

**Fig. 11-1** Damper clamp detail

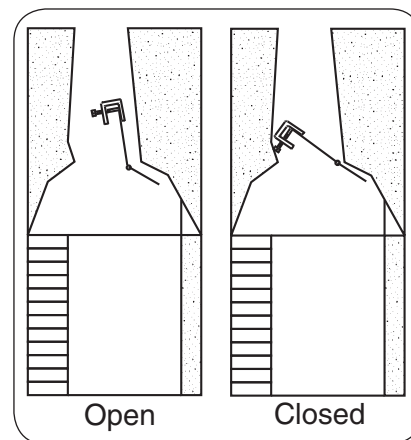

**Fig. 11-2** Damper open / closed

## Venting Requirements

Minimum permanent free opening area of chimney damper for venting (sq. in.)			
For factory-built fireplaces			
Chimney height	18"	24"	30"
15'	20	30	42
20'	17	25	35
30'	13	19	27
For masonry-built fireplaces			
15'	30	41	52
20'	27	37	47
30'	25	34	43

**Table 5 - Minimum Chimney Damper Venting Requirements**

**Note: The minimum chimney height from hearth to top of chimney is 15'.**

**THESE ARE MINIMUM DAMPER OPENING SPECIFICATIONS.**

**THE DAMPER MUST BE COMPLETELY OPENED WHEN OPERATING THIS GAS APPLIANCE TO ACHIEVE THE BEST VENTILATION POSSIBLE.**

# BURNER REPLACEMENT PARTS LIST - MANUAL PILOT (A) SERIES

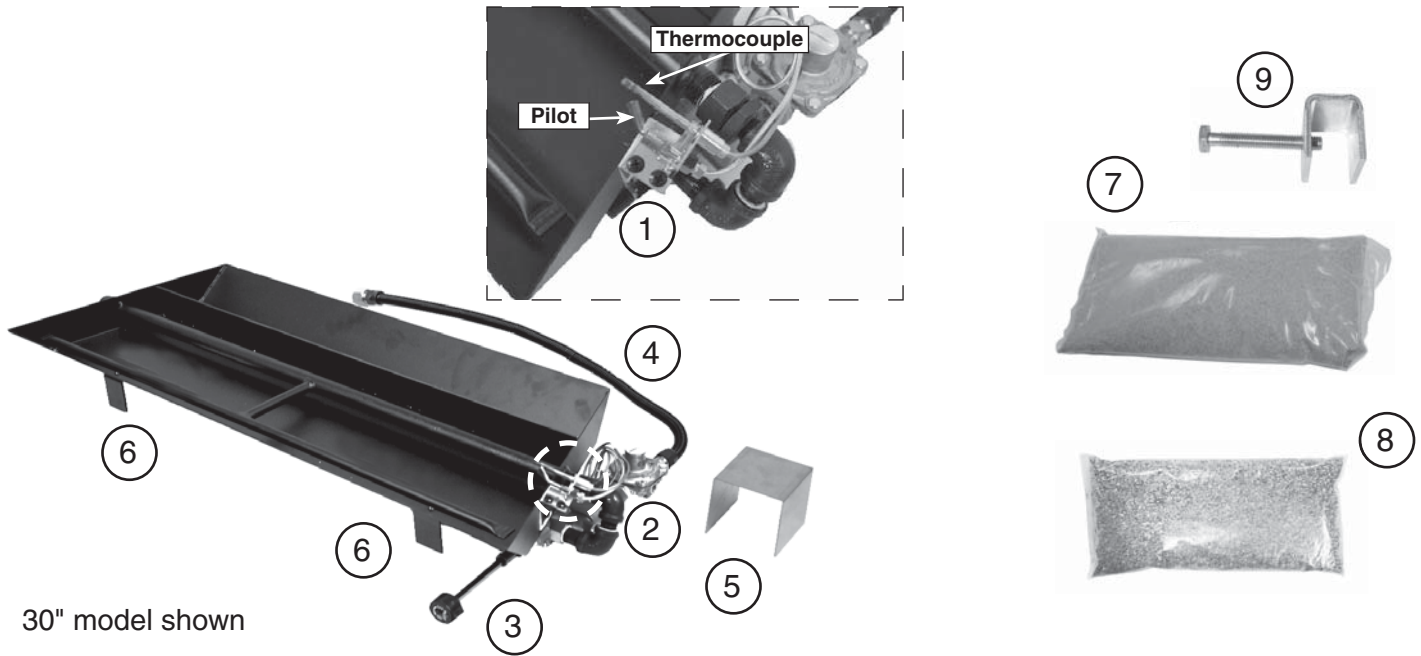

30" model shown

**Note: Photos not to scale**

Replacement parts can be ordered from your local Real Fyre dealer.

The media option (log set/spheres/glass) is purchased and packaged separately; contact your local Real Fyre dealer when ordering. Refer to the instructions included with the media.

Item	Description	18" model		24" model		30" model	
		Part No.	Qty.	Part No.	Qty.	Part No.	Qty.
1.	Pilot assembly (natural)	PAC-1NAT	1	PAC-1NAT	1	PAC-1NAT	1
or	Pilot assembly (propane)	PAC-1LP	1	PAC-1LP	1	PAC-1LP	1
2.	Control valve (natural or propane models)	SV-19	1	SV-19	1	SV-19	1
3.	Valve extension kit (includes extension rod and knob)	EH-12H	1	EH-12H	1	EH-12H	1
4.	Flex connector (w/ adapter), 1/2" O.D. x 24"	CK-5-24	1	CK-5-24	1	CK-5-24	1
5.	Regulator heat shield	HS-41	1	HS-41	1	HS-41	1
6.	Burner legs (set of 2)	PL-2	2	PL-2	2	PL-2	2
7.	Sand (natural gas only)	400071-5	2	400071-16	2	400071-5	3
8.	Vermiculite (natural)	LF-15-7	1	LF-15-7	2	LF-15-7	2
or	Vermiculite (propane)	LF-15	1	LF-15-7	4	LF-15-7	5
9.	Damper clamp	DC-1	1	DC-1	1	DC-1	1

# BURNER REPLACEMENT PARTS LIST - 17 SERIES

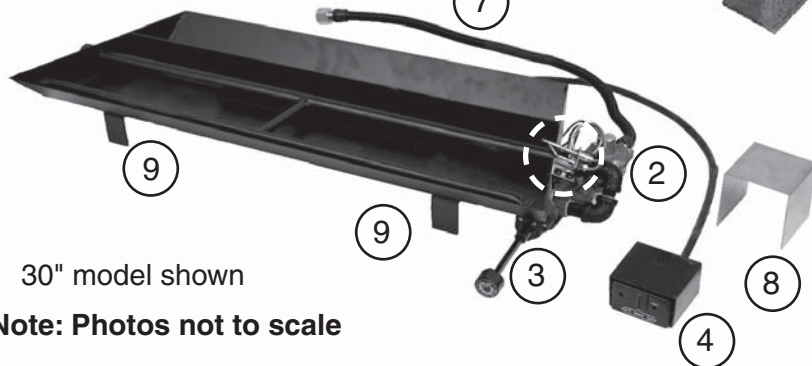
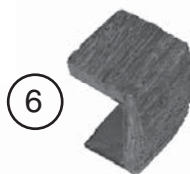
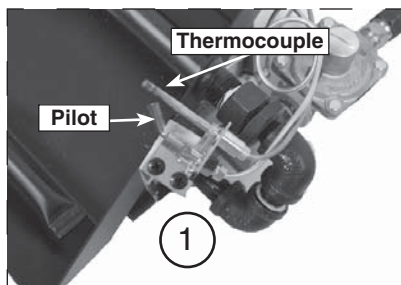

30" model shown

Note: Photos not to scale

Replacement parts can be ordered from your local Real Fyre dealer.

Remote transmitter and receiver batteries included with burner system.

The media option (log set/spheres/glass) is purchased and packaged separately; contact your local Real Fyre dealer when ordering. Refer to the instructions included with the media.

Item	Description	18" model		24" model		30" model	
		Part No.	Qty.	Part No.	Qty.	Part No.	Qty.
1.	Pilot assembly (natural) or Pilot assembly (propane)	PAC-1NAT PAC-1LP	1 1	PAC-1NAT PAC-1LP	1 1	PAC-1NAT PAC-1LP	1 1
2.	Control valve (natural or propane models)	SV-37	1	SV-37	1	SV-37	1
3.	Valve extension kit (includes extension rod and knob)	EH-12H	1	EH-12H	1	EH-12H	1
4.	Remote kit (includes receiver, transmitter, batteries, and plastic cover)	VR-1A	1	VR-1A	1	VR-1A	1
5.	Remote transmitter (only)	AT-V1-1	1	AT-V1-1	1	AT-V1-1	1
6.	Decorative heat shield	HS-36	1	HS-36	1	HS-36	1
7.	Flex connector (w/ adapter), 1/2" O.D. x 24"	CK-5-24	1	CK-5-24	1	CK-5-24	1
8.	Regulator heat shield	HS-41	1	HS-41	1	HS-41	1
9.	Burner legs (set of 2)	PL-2	2	PL-2	2	PL-2	2
10.	Sand (natural gas only)	400071-5	2	400071-16	2	400071-5	3
11.	Vermiculite (natural) or Vermiculite (propane)	LF-15-7 LF-15	1 1	LF-15-7 LF-15-7	2 4	LF-15-7 LF-15-7	2 5
12.	Damper clamp	DC-1	1	DC-1	1	DC-1	1

# INSTALLATION

The Real Fyre burner system must be installed by a qualified professional service technician. Instructions must be followed carefully to ensure proper performance and full benefit from the burner system. **Check to be sure the burner system is designed and labeled for the type of gas (natural or propane gas) supplied to the fireplace. Fireplace floor must be level, clean, and smooth (see FIREPLACE SAFETY INFORMATION section).**

**WARNING:** Failure to position the parts in accordance with these diagrams or failure to use only parts specifically approved with this appliance may result in property damage or personal injury.

REFER TO THE PARTS LIST WHEN FOLLOWING THESE INSTRUCTIONS.

24" 17 burner model shown here.

## BURNER INSTALLATION

1. MAKE SURE THE FIREPLACE GAS SUPPLY IS TURNED OFF.
2. Locate the gas-supply stub inside the fireplace and remove the cap, if attached (reference Fig. 14-1).

**CAUTION:** When removing the cap, make sure the stub does not turn, loosening the connection inside the wall.

3. Place the burner system in the fireplace. Center the burner from left to right in the fireplace. (Reference Fig. 14-3 for orientation.)
4. **Be sure gas to the fireplace is off.** Remove the adapter connected to the flex connector (pre-installed on the burner system). Attach the adapter to the gas-supply stub using a pipe compound resistant to all gasses. Tighten securely. Then attach the open end of the flex connector to the adapter. Tighten securely (see Fig. 14-1).

5. Place regulator heat shield firmly over the regulator (see Fig. 14-2).

6. **LEAK TEST:** Turn on the fireplace gas supply, and test at all connections for leaks using the appropriate soapy water solution. If bubbles appear, a leak is present. Turn off the gas and tighten at all connections. Repeat until no leaks are present. If a leak persists, turn off the gas supply and contact the local gas company or dealer. **NEVER USE A FLAME TO CHECK FOR LEAKS.**

**For manual pilot models, continue to the following section.**

7. At this stage the burner system batteries are to be installed. Reference the INSTALLING/REPLACING BATTERIES section for details.
8. **Place the plastic cover over the receiver, then place at the front right corner of the fireplace.** Place as far from the burner system as possible. See Fig. 14-3.

**Important:** Ensure that the remote wire remains away from the burner system and its flame during operation.

9. Place the decorative heat shield over the remote receiver box as shown in Fig. 14-4.

**CAUTION: THE REMOTE RECEIVER/DECORATIVE HEAT SHIELD WILL BE HOT DURING AND AFTER OPERATION.**

## LIGHTING TEST

Prior to proceeding with installation, perform a lighting test (see lighting instructions for lighting your burner). **Allow the unit to completely cool after testing.**

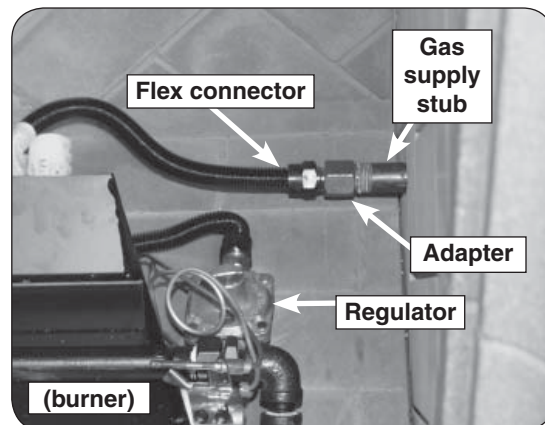

Fig. 14-1 Connect burner to gas supply

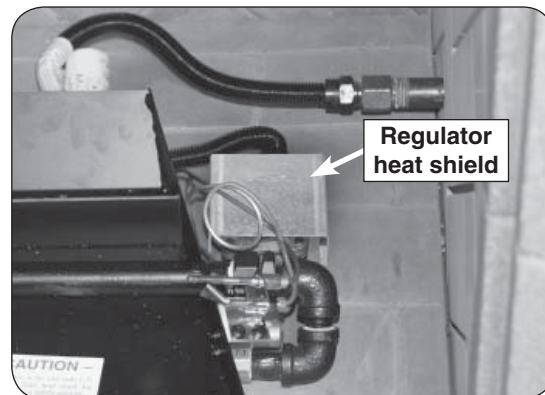

Fig. 14-2 Place regulator heat shield

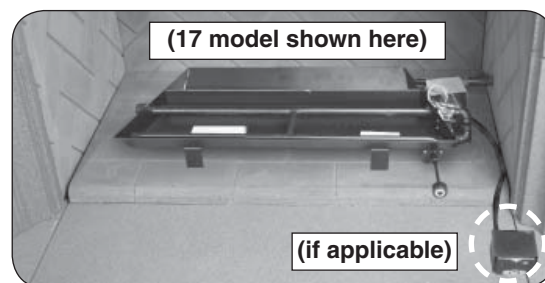

Fig. 14-3 Orientation (place receiver if applicable)

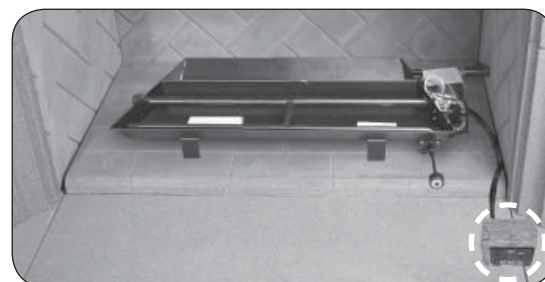

Fig. 14-4 Place heat shield (if applicable)

**THIS SECTION ADDRESSES INSTALLATION WITH A LOG SET OR FYRE SPHERES ONLY.**

If installing with glass media, refer to the following INSTALLATION - GLASS MEDIA MODELS section.

## LAVA GRANULES/COALS (optional)

Optional lava granules and lava coals are available for decorative purposes. Contact your dealer for ordering information. If purchased, follow the steps below.

1. Spread the lava granules on the floor of the fireplace, around the front and sides of the burner system (see Fig. 15-1).
2. Repeat this process for the lava coals (on top of the already placed lava granules).

**Note:** DO NOT place any lava media on the burner system, behind it, or under the knob and extension rod (see Fig. 12-2).

## SAND AND/OR VERMICULITE PLACEMENT

The sand and/or vermiculite supplied with the unit is specially selected for use with natural gas or propane gas. They maximize flame distribution and provide a cleaner burning flame.

**CAUTION:** Use only the sand and/or vermiculite provided for this burner.

### Natural Gas

1. Fill the burner pan with the supplied bag of sand (see Fig. 15-3). **Avoid spilling the sand on the pilot assembly.**

**Note:** Gently shake the burner pan and/or tap it on the fireplace floor to ensure the sand settles in the pan. The sand should rest at a level approximately halfway up the center burner tube.

2. Fill the burner pan completely with the supplied bag of vermiculite (see Fig. 15-4). The vermiculite is poured directly onto the already placed sand. **Avoid spilling the vermiculite on the pilot assembly.**

**Important:** Ensure the vermiculite is level with the top of the burner pan. This is important to ensure quiet lighting and even flame distribution.

### Propane Gas

1. Fill the burner pan completely with the supplied bag of vermiculite (see Fig. 15-4). **Avoid spilling the vermiculite on the pilot assembly.**

**Important:** Ensure the vermiculite is level with the top of the burner pan. This is important to ensure quiet lighting and even flame distribution.

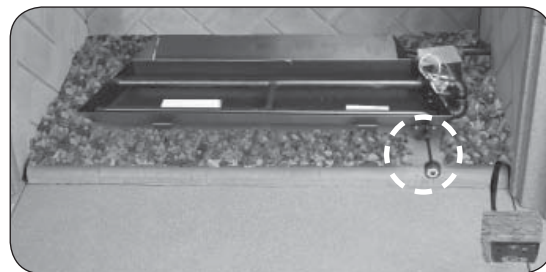

**Fig. 15-1** Place lava media (if purchased)

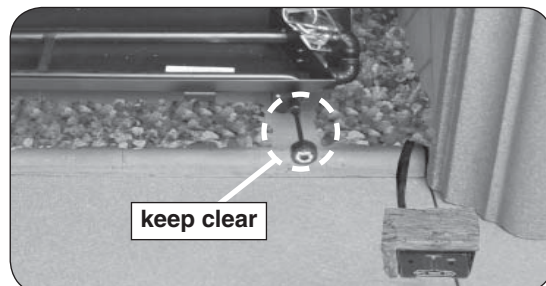

**Fig. 15-2** Proper media placement

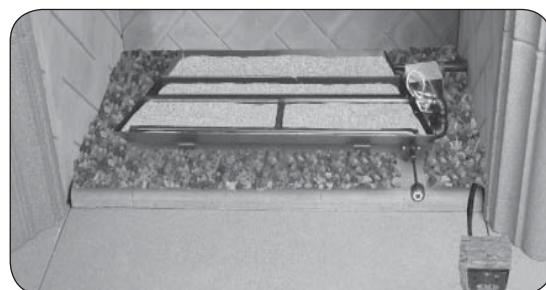

**Fig. 15-3** Place sand (if applicable)

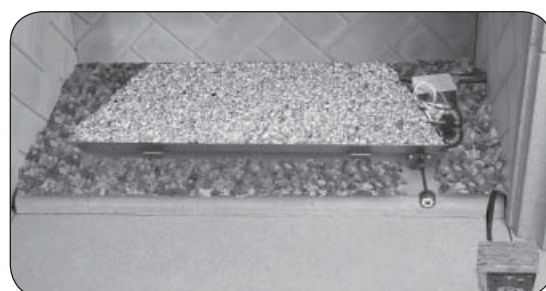

**Fig. 15-4** Place vermiculite

## IMPORTANT

For all valves, the air **MUST** be purged from the gas line before the pilot will light and burn properly. The time needed to purge will depend on the length of the gas line to the unit and the amount of time since the unit or gas line was last used. It may take several minutes before all the air is purged and the pilot will light and burn properly. Reference the LIGHTING INSTRUCTIONS section in this manual.

## LOG SET PLACEMENT

- Follow the instructions included with the log set for step by step log and ember placement.
- Read all safety warnings and important information in the instructions supplied with the log set to ensure proper placement.

Below are examples of the log sets currently available for this burner system:



Shoreline Oak (SO-24)



Shoreline Driftwood (SDW-24)

**Important:** **Adequate ventilation is absolutely necessary!** Provided significant, noticeable sooting does not occur, some flexibility is possible in log placement to suit your individual preference. If you experience a continued accumulation of black carbon (soot) on your logs it is an indication of incomplete combustion and you should move the effected log(s) so as to minimize the flame contact on the effected log(s). Read the instructions supplied with the log set completely and carefully.

**CAUTION:** **BURN HAZARD!** Logs will remain hot for some time after use. If you need to reposition any log to maintain the proper layout, use heat-resistant gloves or allow logs adequate time to cool before handling.



## FYRE SPHERES PLACEMENT

You must position and maintain the sphere layout as shown here to ensure optimal operation of the burner system. **Do not add any additional spheres to this burner system. Any additional spheres may cause unsafe operation. Locate the section applicable to your model selected.**

**CAUTION: BURN HAZARD!** Spheres will remain hot for some time after use. If you need to reposition any sphere to maintain the proper layout, use heat-resistant gloves or allow spheres adequate time to cool before handling.

### 18" Models

**4" spheres**

Spheres per row	
4"	5"
3	2
4	3
5	4

**5" spheres**

Place the first level of the spheres on the burner pan in 3 rows as shown above.

- Be sure to place the amount of spheres in each row as indicated. Amount will vary depending on the size of the spheres being used (4" or 5"). See chart and images above.
- Be sure that the spheres are evenly spread out on the pan. This may result in small gaps in between the spheres.

Spheres per row	
4"	5"
3	2
4	3

Place the second level of the spheres (on the spheres below) in 2 rows as shown above.

- Be sure to place the amount of spheres in each row as indicated. Amount will vary depending on the size of the spheres being used (4" or 5"). See chart and images above.
- Be sure that the spheres are evenly spread out on the spheres below. This may result in small gaps in between the spheres.

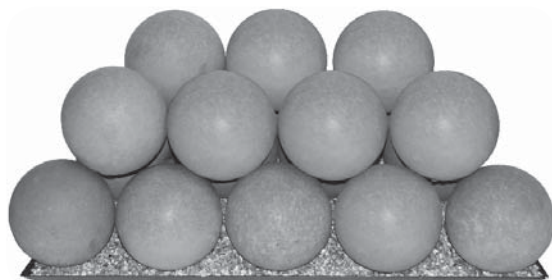

**Complete 4" Sphere Setup - Front View**

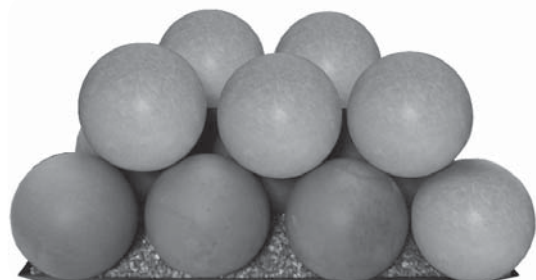

**Complete 5" Sphere Setup - Front View**

# INSTALLATION - LOG SET AND FYRE SPHERE MODELS (cont.)

## 24" Models

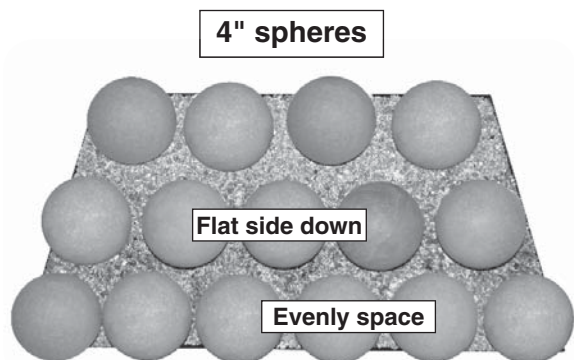

Spheres per row	
4"	5"
4	3
5	4
6	5

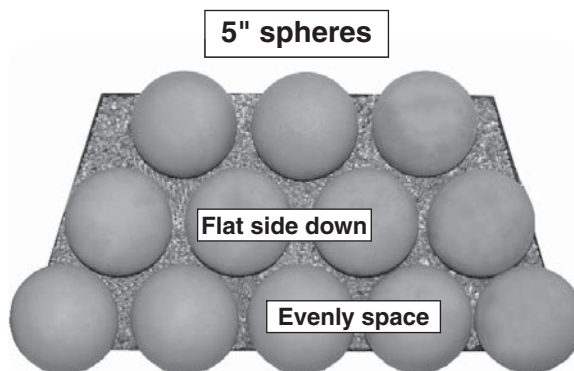

Place the first level of the spheres on the burner pan in 3 rows as shown above.

- Be sure to place the amount of spheres in each row as indicated. Amount will vary depending on the size of the spheres being used (4" or 5"). See chart and images above.
- Be sure that the spheres are evenly spread out on the pan. This may result in small gaps in between the spheres.

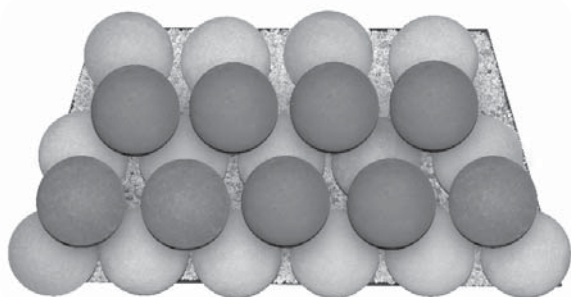

Spheres per row	
4"	5"
4	3
5	4

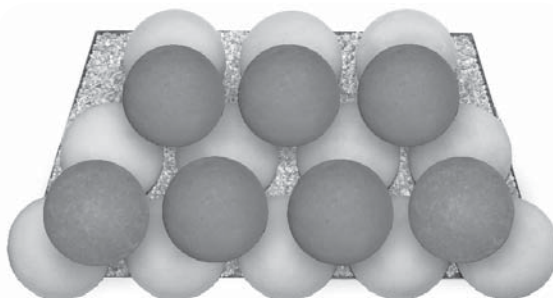

Place the second level of the spheres (on the spheres below) in 2 rows as shown above.

- Be sure to place the amount of spheres in each row as indicated. Amount will vary depending on the size of the spheres being used (4" or 5"). See chart and images above.
- Be sure that the spheres are evenly spread out on the spheres below. This may result in small gaps in between the spheres.

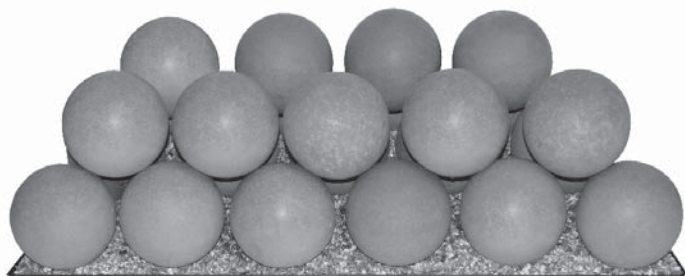

**Complete 4" Sphere Setup - Front View**

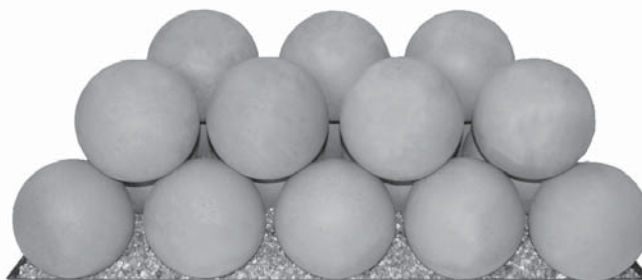

**Complete 5" Sphere Setup - Front View**

# INSTALLATION - LOG SET AND FYRE SPHERE MODELS (cont.)

## 30" Models

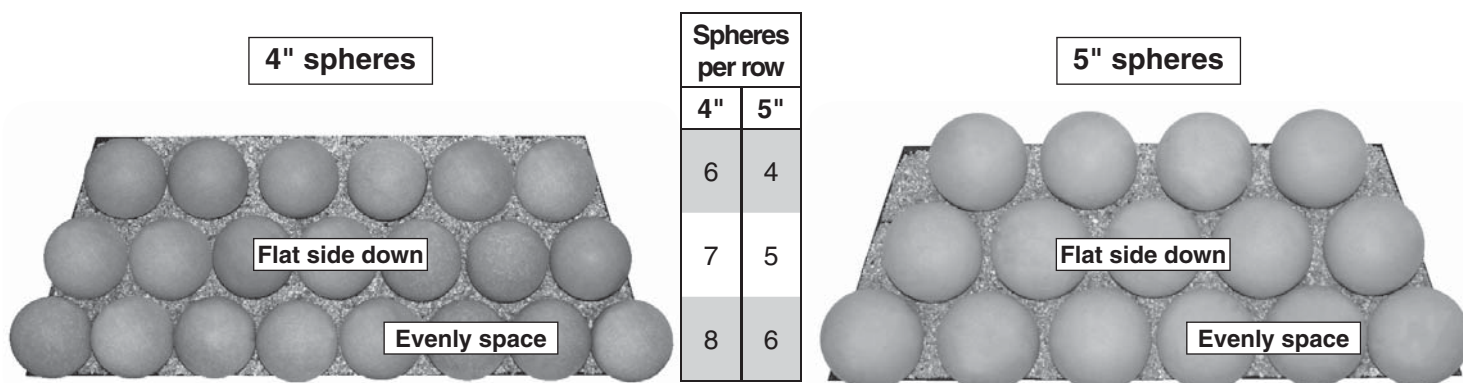

Place the first level of the spheres on the burner pan in 3 rows as shown above.

- Be sure to place the amount of spheres in each row as indicated. Amount will vary depending on the size of the spheres being used (4" or 5"). See chart and images above.
- Be sure that the spheres are evenly spread out on the pan. This may result in small gaps in between the spheres.

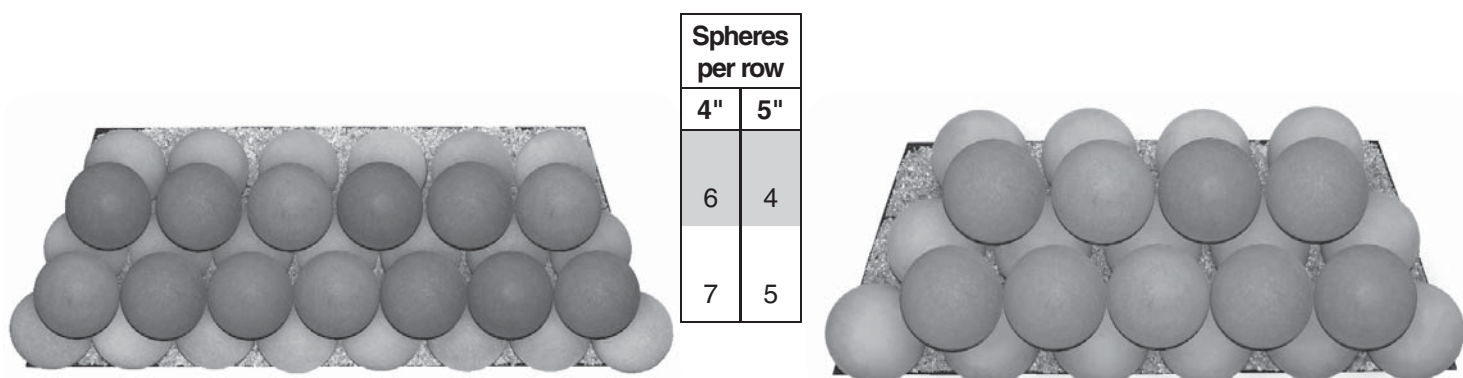

Place the second level of the spheres (on the spheres below) in 2 rows as shown above.

- Be sure to place the amount of spheres in each row as indicated. Amount will vary depending on the size of the spheres being used (4" or 5"). See chart and images above.
- Be sure that the spheres are evenly spread out on the spheres below. This may result in small gaps in between the spheres.

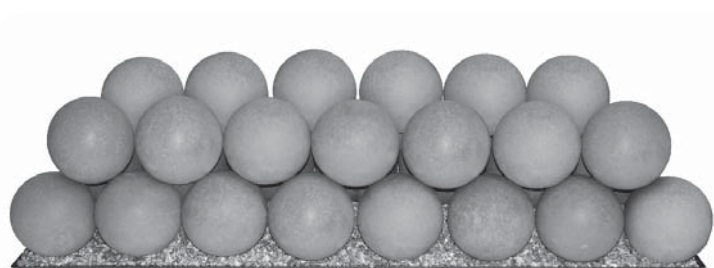

**Complete 4" Sphere Setup - Front View**



**Complete 5" Sphere Setup - Front View**

## INSTALLATION - GLASS MEDIA MODELS

### **THIS SECTION ADDRESSES INSTALLATION WITH GLASS MEDIA ONLY.**

If installing with a log set or Fyre Spheres, refer to the previous INSTALLATION - LOG SET AND FYRE SPHERES MODELS section.

### **SAND / VERMICULITE PLACEMENT**

The sand/vermiculite supplied with the unit is specially selected for use with either natural gas or propane gas. It maximizes flame distribution and provides a cleaner burning flame.

**CAUTION:** Use only sand for natural gas burners and vermiculite for propane gas burners.

#### **Natural Gas**

**Important:** **DO NOT** use the bag of vermiculite when installing this burner system with glass. Set the vermiculite aside or discard. Only use the bag of sand.

1. Fill the burner pan with the supplied bag of sand (see Fig. 20-1). **Avoid spilling the sand on the pilot assembly.**

**Note:** Gently shake the burner pan and/or tap it on the fireplace floor to ensure the sand settles in the pan. The sand should rest at a level approximately halfway up the center burner tube.

#### **Propane Gas**

1. Partially fill the burner pan with the supplied bag of vermiculite until it rests at a level approximately halfway up the center burner tube. **Leave space within the pan to allow for glass placement. See Fig 20-1. Avoid spilling the vermiculite on the pilot assembly. Store excess vermiculite in a safe location.**

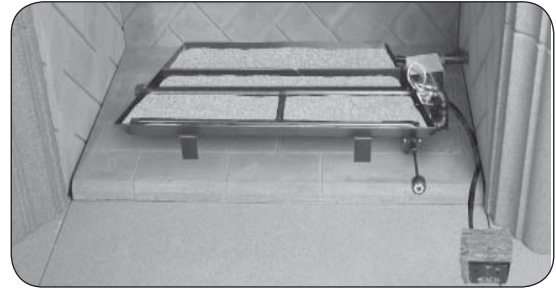

**Fig. 20-1** Place sand/vermiculite

### **IMPORTANT**

For all valves, the air **MUST** be purged from the gas line before the pilot will light and burn properly. The time needed to purge will depend on the length of the gas line to the unit and the amount of time since the unit or gas line was last used. It may take several minutes before all the air is purged and the pilot will light and burn properly. Reference the LIGHTING INSTRUCTIONS section in this manual.

## GLASS / GEMS PLACEMENT

**CAUTION:** Glass pieces may have sharp edges. Be careful handling the glass. Use hand protection, such as gloves, if necessary.

Glass / gems must be installed on the burner for the system to operate properly. The glass media is purchased and packaged separately. Contact your local Real Fyre dealer for ordering information.

Reference the SPECIFICATIONS section for details on the recommended amounts of media.

1. **After the required sand/vermiculite has been placed**, pour the glass media (glass, gems) evenly into the burner pan (see Fig. 21-1). The glass should be flush with the top of the pan. **DO NOT** overfill.

**Important:** Do not add any additional glass / gems to this burner system. Any additional glass / gems may cause unsafe operation.

## DECORATIVE MEDIA ON FIREPLACE FLOOR (optional)

Optional glass, gems, or lava media may be placed on the fireplace floor as an enhancement to the burner system.

If purchased; spread the decorative media on the floor of the fireplace, around the front and sides of the burner system. See Fig. 21-2 for an example (glass shown).

**CAUTION:** DO NOT place any of this additional media on the burner system, behind it, or under the knob and extension rod (see Fig. 21-3).

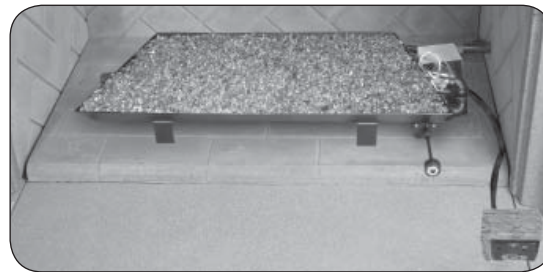

Fig. 21-1 Place glass media

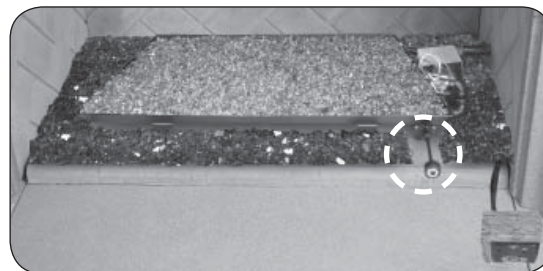

Fig. 21-2 Decorative media floor placement

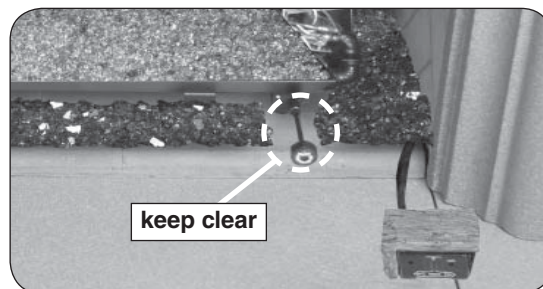

Fig. 21-3 Proper media placement

**CAUTION: BURN HAZARD. GLASS AND/OR GEMS ON BURNER SYSTEM WILL REMAIN HOT FOR SOME TIME AFTER USE.** You must maintain the placement as shown to ensure proper operation of the burner system. If you need to reposition any media to maintain the proper layout, use heat-resistant gloves or allow media adequate time to cool before handling.

## INSTALLING/REPLACING BATTERIES (IF APPLICABLE)

**CAUTION:** Ensure the unit is connected to the gas line and has been tested for leaks before you insert batteries.

**CAUTION:** Turn off the remote and/or burner and allow the unit to completely cool prior to any battery replacements.

**Important:** Prior to inserting batteries, always apply a small amount of dielectric grease to both ends of each battery. This will ensure conductivity and prevent moisture from affecting the contact.

**Important:** **Low/dead batteries will affect burner system operation. Replace batteries any time the burner will not turn on.**



Fig. 22-1 Transmitter battery

### REMOTE TRANSMITTER BATTERY

The remote transmitter requires one 12V battery to operate (included). Locate the transmitter, remove the lid (found on rear), and properly insert the new battery as marked. Re-secure the lid. See Fig. 22-1.

### REMOTE RECEIVER BATTERIES

The remote receiver requires 4 AA batteries to operate (included). Locate the remote receiver and turn it over. Slide open the lid, and properly insert the new batteries as marked. See Fig. 22-2.

Replace the lid, then re-position the remote receiver in the fireplace. (Ensure the plastic cover and decorative heat shield are properly in place over the receiver.)

**Important:** Be sure to replace the decorative heat shield over the receiver after battery replacement.

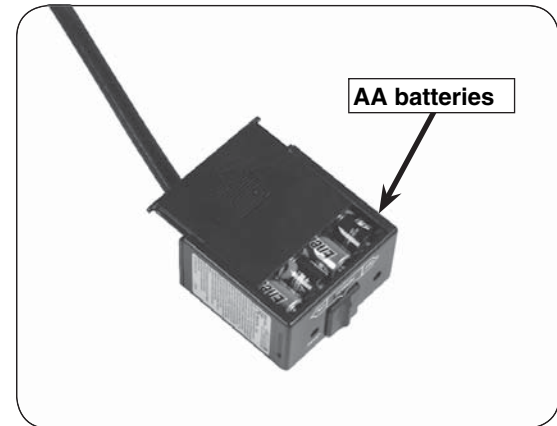

Fig. 22-2 Remote receiver batteries

## OPTIONAL ACCESSORIES

Optional decorative fenders are available for your burner system. Contact your local dealer for ordering information.

Follow all instructions provided with the fender.

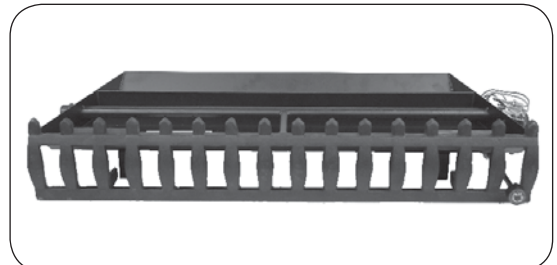

Fig. 22-3 Fender option (FF-04 series)

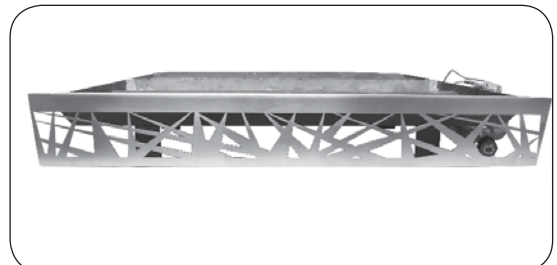

Fig. 22-4 Nest fender option (FF-05 series)

# LIGHTING INSTRUCTIONS - MANUAL PILOT (A) SERIES

## FOR YOUR SAFETY, READ BEFORE LIGHTING

**WARNING: If you do not follow these instructions exactly, a fire or explosion may result causing property damage, personal injury or loss of life.**

- A.** Use only your hand to push in or turn the gas control knob. Never use tools. If the knob will not push in or turn by hand, don't try to repair it. Call a qualified professional service technician. Excessive force or attempted repair may result in fire or explosion.
- B. BEFORE OPERATING,** smell all around the appliance area for gas. Be sure to smell next to the floor because some gas is heavier than air and will settle on the floor.

### WHAT TO DO IF YOU SMELL GAS

- Do not light any appliance.
  - Do not touch any electric switch; do not use any phone in your building.
  - Immediately call your gas supplier from a neighbor's phone. Follow the gas supplier's instructions. If you cannot reach your gas supplier, call the fire department.
- C.** The burner system has a pilot that can be lit by hand using a long fireplace match or lighter. When lighting the pilot, follow these instructions exactly.
- D.** Do not use this appliance if any part has been underwater. Immediately call a qualified service technician to inspect the appliance and to replace any part of the control system and any gas control which has been underwater. Attempted operation may result in fire or explosion resulting in property damage, personal injury or loss of life.

### LIGHTING THE PILOT

1. Locate the valve on the side of the unit. Push in the gas control knob slightly and turn clockwise to **OFF** (Fig. 23-1).

**Note:** The control knob cannot be turned from **PILOT** to **OFF** unless the knob is pushed in slightly. Do not force.

**Allow five (5) minutes for any gas in the unit to dissipate. IF YOU SMELL GAS, SEE STEP B ABOVE.** If you don't smell gas, go on to step 2.

2. Turn the control knob counterclockwise to **PILOT** (Fig. 23-1). Push the control knob **firmly and fully** in and hold. Hold a long fireplace match or lighter near the thermocouple to light the pilot. Continue to hold the control knob in for approximately 60 seconds after the pilot is lit, then release the knob. The pilot will remain lit.

**WARNING: If the pilot fails to light repeat steps 1 and 2.**

If the pilot fails to light after several tries, turn the control knob to **OFF** and contact a qualified professional service technician.

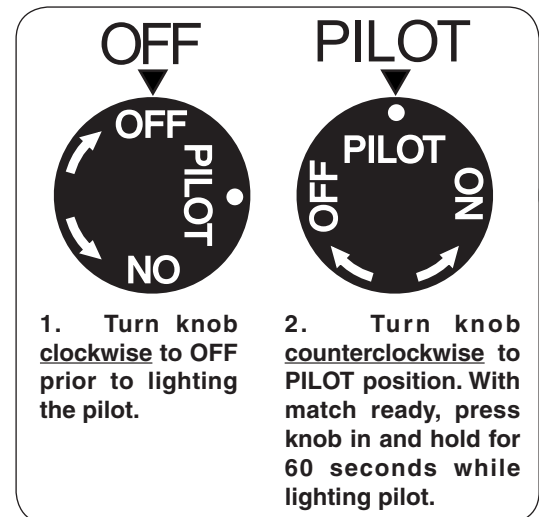

**Fig. 23-1** Control knob detail (OFF, PILOT)

# INSTRUCTIONS D'ALLUMAGE - SÉRIE MANUEL PILOTE (A)

## POUR VOTRE SÉCURITÉ, LISEZ AVANT D'ALLUMER

**AVERTISSEMENT:** Si vous ne suivez pas ces instructions à la lettre, un incendie ou une explosion entraînant des dommages matériels, des blessures ou des pertes de vie.

- A.** N'utilisez que votre main pour enfoncer ou tourner le bouton de contrôle du gaz. Ne jamais utiliser d'outils. Si le bouton ne sera pas enfoncer ou à tourner à la main, n'essayez pas de le réparer. Appelez un technicien de service qualifié. Une force excessive ou une tentative de réparation pourrait provoquer un incendie ou une explosion.
- B. AVANT DE FAIRE FONCTIONNER,** sentez autour de l'appareil pour le gaz. Assurez-vous de sentir près du plancher, car certains gaz sont plus lourds que l'air et se déposent sur le sol.

### QUE FAIRE SI UNE ODEUR DE GAZ

- Ne pas allumer l'appareil.
  - Ne touchez à aucun interrupteur électrique; n'utilisez aucun téléphone dans votre bâtiment.
  - Appelez immédiatement votre fournisseur de gaz à partir du téléphone d'un voisin. Suivez les instructions du fournisseur de gaz. Si vous ne pouvez joindre votre fournisseur de gaz, appeler les pompiers.
- C.** Le système de brûleur a un pilote qui peut être allumée à la main à l'aide d'une allumette ou long cou léger. Pour allumer la veilleuse, suivez ces instructions à la lettre.
- D.** Ne pas utiliser cet appareil si une partie quelconque a été submergée. Appelez immédiatement un technicien de service qualifié pour inspecter l'appareil et pour remplacer toute pièce du système de contrôle et toute commande de gaz qui a été sous l'eau. Tentative d'opération peut entraîner un incendie ou une explosion entraînant des dommages matériels, des blessures ou des pertes de vie.

### ALLUMAGE DU PILOTE

1. Localiser la vanne sur le côté de l'appareil. Appuyer sur le bouton légèrement de contrôle du gaz et tourner dans le sens horaire à **OFF** (Fig. 24-1).

**Note:** Le bouton de commande ne peut être activée à partir **PILOTE** sur **OFF** si le bouton est enfoncé légèrement. Ne pas forcer.

**Attendez cinq (5) minutes pour n'importe quel gaz dans l'unité de se dissiper. S'IL YA UNE ODEUR DE GAZ, voir l'étape B CI-DESSUS.** Si vous ne sentez pas de gaz, passez à l'étape 2.

2. Tournez le bouton de réglage dans le sens antihoraire pour **PILOTE** (Fig. 24-1). Appuyez sur le bouton de commande **fermement et pleinement** enfoncée. Mantenga partido largo chimenea o un encendedor cerca del termopar a encender el piloto. Continúe a tenir le bouton de commande pendant environ 60 secondes après que le pilote est allumé, puis relâchez le bouton. Le pilote reste allumé.

**AVERTISSEMENT:** Si le pilote ne s'allume pas, répétez les étapes 1 et 2.

Si la télécommande ne fonctionne pas, et des batteries avec un niveau de puissance adéquate sont installés, reportez-vous à la synchronisation des section REMOTE.

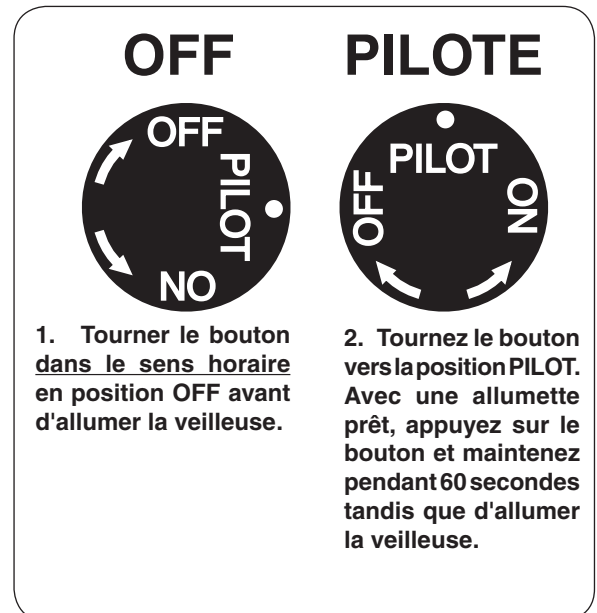

**Fig. 24-1** Détail bouton de commande (OFF, PILOTE)



## LIGHTING THE BURNER

1. Ensure the pilot is burning. Turn the gas control knob counterclockwise to **ON** (Fig. 25-1) to ignite the burner. The valve will open and the burner will light.

**Note:** The ignition sequence will take approximately 5 seconds.

**WARNING:** If the burner fails to light within 5 seconds, turn the control knob clockwise to **PILOT**. Allow five (5) minutes for any gas in the unit to dissipate, then repeat step 1 above. **IF YOU SMELL GAS, SEE STEP B AT BEGINNING OF LIGHTING INSTRUCTIONS.**

If the burner fails to light after several tries, push in the control knob slightly and turn clockwise to **OFF**, and contact a qualified professional service technician.

## SHUTTING DOWN

**MAIN BURNER ONLY (pilot will remain lit):**

Turn the control knob clockwise to **PILOT**.

**BURNER AND PILOT (total shutdown):**

If you do not plan on using your burner system for an extended period (one week or more), **you may extinguish the pilot.** This will conserve energy and save you money.

Push in the control knob slightly and turn clockwise to **OFF**.

## PILOT BURNER CHECK/ADJUSTMENT

With the pilot burner lit and the control knob in the pilot position, check the pilot system for proper flame size and appearance (see Fig. 25-2). The pilot adjustment screw is located on the front of the gas valve (see Fig. 25-2). Using a small flat head screwdriver, adjust the pilot screw to properly size the flames. Turning the screw clockwise will lower the flames, and turning it counterclockwise will raise them. Be careful not to back the screw out of its threads.

The pilot flame should be a quiet, soft blue flame with yellow tipping that encircles the thermocouple tip.

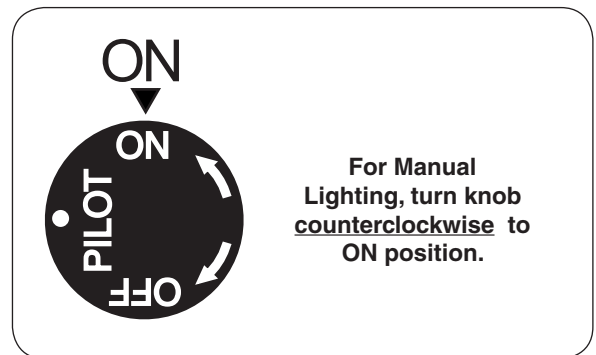

Fig. 25-1 Control knob detail (ON)

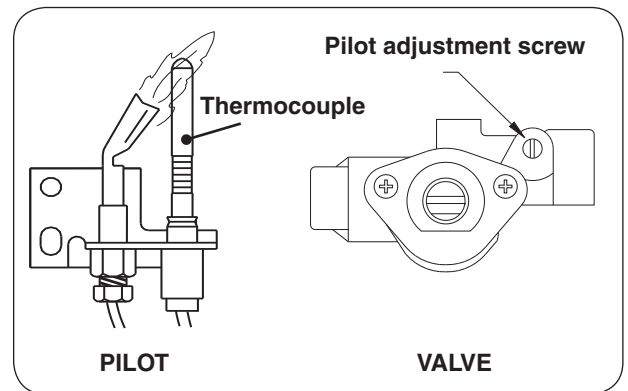

Fig. 25-2 Pilot adjustment detail

## ALLUMER LE BRÛLEUR

1. Assurer la veilleuse est allumée. Tournez le bouton de contrôle du gaz dans le sens antihoraire sur **ON** (Fig. 26-3) pour allumer le brûleur. La vanne s'ouvre et le brûleur s'allume.

**Note:** La séquence d'allumage dure environ 5 secondes.

**WARNING:** Si le brûleur ne s'allume pas dans les 5 secondes, tournez le bouton de commande vers la droite pour **PILOT**. Permettre aux cinq (5) minutes pour tout gaz de l'unité de dissiper, puis répétez l'étape 1 ci-dessus. **SI VOUS UNE ODEUR DE GAZ, voir l'étape B AU DÉBUT DE instructions d'allumage.**

Si le brûleur ne s'allume pas après plusieurs tentatives, appuyez sur le bouton de commande et tournez légèrement à **OFF** et contactez un technicien qualifié.

## ARRÊT

**BRÛLEUR SEULEMENT (pilote reste allumé):**

Tournez le bouton de commande vers la droite pour **PILOT**.

**BRÛLEUR ET LA VEILLEUSE (arrêt total):**

Si vous ne prévoyez pas d'utiliser votre système de brûleur pour une longue période (une semaine ou plus), **vous pouvez éteindre le pilote**. Ce sera de conserver l'énergie et économiser de l'argent.

Enfoncez légèrement le bouton de commande et tournez dans le sens horaire sur **OFF**.

## VEILLEUSE CONTROLE/REGLAGE

Avec le brûleur de la veilleuse allumée et le bouton de commande dans le poste de pilotage, vérifier le système de pilotage de la taille de la flamme correspondant et l'apparence (voir Fig. 26-1). La vis de réglage de la veilleuse se trouve sur la face de la soupape à gaz (voir Fig. 26-1). L'aide d'un petit tournevis à tête plate, ajustez la vis de la veilleuse pour dimensionner correctement les flammes. Tourner la vis dans le sens horaire réduira les flammes, et en tournant dans le sens antihoraire leur suscitera. Veillez à ne pas desserrer la vis de ses fils.

La flamme de la veilleuse devrait être tranquille, flamme bleu pâle avec des pointes jaunes qui entoure la pointe du thermocouple.



Fig. 26-1 Détail bouton de commande (SUR)

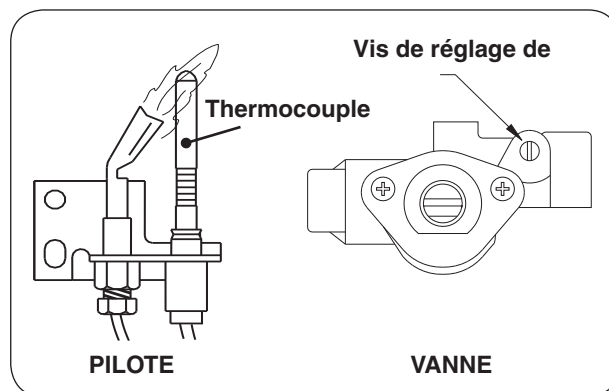

Fig. 26-2 Détail réglage de la veilleuse

# LIGHTING INSTRUCTIONS - 17 SERIES

## FOR YOUR SAFETY, READ BEFORE LIGHTING

**WARNING:** If you do not follow these instructions exactly, a fire or explosion may result causing property damage, personal injury or loss of life.

- A. Use only your hand to push in or turn the gas control knob. Never use tools. If the knob will not push in or turn by hand, don't try to repair it. Call a qualified professional service technician. Excessive force or attempted repair may result in fire or explosion.
- B. **BEFORE OPERATING**, smell all around the appliance area for gas. Be sure to smell next to the floor because some gas is heavier than air and will settle on the floor.

### WHAT TO DO IF YOU SMELL GAS

- Do not light any appliance.
  - Do not touch any electric switch; do not use any phone in your building.
  - Immediately call your gas supplier from a neighbor's phone. Follow the gas supplier's instructions. If you cannot reach your gas supplier, call the fire department.
- C. The burner system has a pilot that can be lit by hand using a long fireplace match or lighter. When lighting the pilot, follow these instructions exactly.
  - D. Do not use this appliance if any part has been under water. Immediately call a qualified service technician to inspect the appliance and to replace any part of the control system and any gas control which has been under water. Attempted operation may result in fire or explosion resulting in property damage, personal injury or loss of life.

### LIGHTING THE PILOT

1. Locate the valve on the side of the unit. Push in the gas control knob slightly and turn clockwise to **OFF** (Fig. 27-1).

**Note:** The control knob cannot be turned from **PILOT** to **OFF** unless the knob is pushed in slightly. Do not force.

**Allow five (5) minutes for any gas in the unit to dissipate. IF YOU SMELL GAS, SEE STEP B ABOVE.** If you don't smell gas, go on to step 2.

2. Turn the control knob counterclockwise to **PILOT** (Fig. 27-1). Push the control knob **firmly and fully** in and hold. Hold a long fireplace match or lighter near the thermocouple to light the pilot. Continue to hold the control knob in for approximately 60 seconds after the pilot is lit, then release the knob. The pilot will remain lit.

**WARNING:** If the pilot fails to light repeat steps 1 and 2.

If the pilot fails to light after several tries, turn the control knob to **OFF** and contact a qualified professional service technician.

### REMOTE LIGHTING

**Note:** If the remote does not function, and batteries with an adequate power level are installed, refer to the SYNCING THE REMOTE section.

**Note:** Step 1 may not be required if previously done during an earlier lighting.

1. Ensure the pilot is burning. Then locate the 3-position switch on the remote receiver (see Fig. 27-2), and slide the switch to the **REMOTE** position.

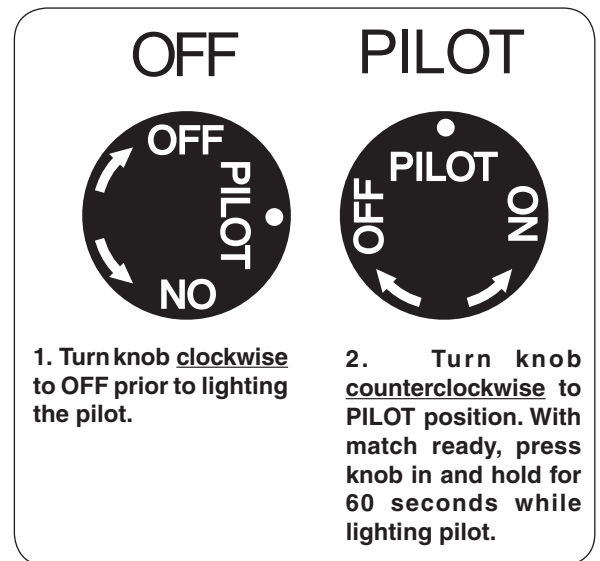

Fig. 27-1 Control knob detail (OFF, PILOT)

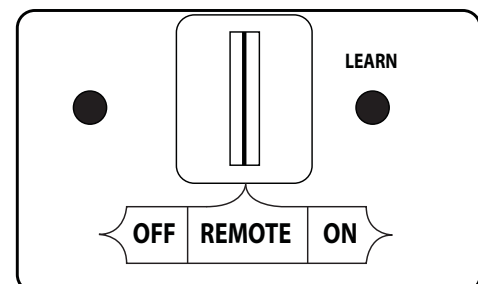

Fig. 27-2 Remote receiver detail (REMOTE)

# INSTRUCTIONS D'ALLUMAGE - 17 SÉRIE

## POUR VOTRE SÉCURITÉ, LISEZ AVANT D'ALLUMER

**AVERTISSEMENT:** Si vous ne suivez pas ces instructions à la lettre, un incendie ou une explosion entraînant des dommages matériels, des blessures ou des pertes de vie.

- A.** N'utilisez que votre main pour enfoncer ou tourner le bouton de contrôle du gaz. Ne jamais utiliser d'outils. Si le bouton ne sera pas enfoncer ou à tourner à la main, n'essayez pas de le réparer. Appelez un technicien de service qualifié. Une force excessive ou une tentative de réparation pourrait provoquer un incendie ou une explosion.
- B. AVANT DE FAIRE FONCTIONNER,** sentez autour de l'appareil pour le gaz. Assurez-vous de sentir près du plancher, car certains gaz sont plus lourds que l'air et se déposent sur le sol.

### QUE FAIRE SI UNE ODEUR DE GAZ

- Ne pas allumer l'appareil.
  - Ne touchez à aucun interrupteur électrique; n'utilisez aucun téléphone dans votre bâtiment.
  - Appelez immédiatement votre fournisseur de gaz à partir du téléphone d'un voisin. Suivez les instructions du fournisseur de gaz. Si vous ne pouvez joindre votre fournisseur de gaz, appeler les pompiers.
- C.** Le système de brûleur a un pilote qui peut être allumée à la main à l'aide d'une allumette ou long cou léger. Pour allumer la veilleuse, suivez ces instructions à la lettre.
- D.** Ne pas utiliser cet appareil si une partie quelconque a été submergée. Appelez immédiatement un technicien de service qualifié pour inspecter l'appareil et pour remplacer toute pièce du système de contrôle et toute commande de gaz qui a été sous l'eau. Tentative d'opération peut entraîner un incendie ou une explosion entraînant des dommages matériels, des blessures ou des pertes de vie.

## ALLUMAGE DE LA VEILLEUSE

1. Localiser la vanne sur le côté gauche de l'appareil. Appuyer sur le bouton de contrôle du gaz et tourner dans le sens horaire en position **OFF** (Fig. 28-1).

**Note:** Le bouton de commande ne peut être activée à partir **PILOTE** sur **OFF** si le bouton est enfoncé légèrement. Ne pas forcer.

**Attendez cinq (5) minutes pour n'importe quel gaz dans l'unité de se dissiper. S'IL YA UNE ODEUR DE GAZ, voir l'étape B CI-DESSUS.** Si vous ne sentez pas de gaz, passez à l'étape 2.

2. Tournez le bouton de réglage dans le sens antihoraire pour **PILOTE** (Fig. 28-1). Appuyez sur le bouton de commande **fermement et pleinement** enfoncée. Mantenga partido largo chimenea o un encendedor cerca del termopar a encender el piloto. Continúe a tenir le bouton de commande pendant environ 60 secondes après que le pilote est allumé, puis relâchez le bouton. Le pilote reste allumé.

**AVERTISSEMENT:** Si le pilote ne s'allume pas, répétez les étapes 1 et 2.

Si la télécommande ne fonctionne pas, et des batteries avec un niveau de puissance adéquate sont installés, reportez-vous à la synchronisation des section REMOTE.

## DISTANCE DE L'ÉCLAIRAGE

Si la télécommande ne fonctionne pas, et que les batteries sont installées, reportez-vous à la synchronisation des section REMOTE.

**Note:** Étape 1 ne peut être exigé s'il a déjà été fait au cours d'un éclairage plus tôt.

1. Assurer la veilleuse est allumée. Ensuite, localisez le commutateur à 3 positions sur le récepteur de la télécommande (voir Fig. 28-2), Et faites glisser le commutateur sur la position **REMOTE**.

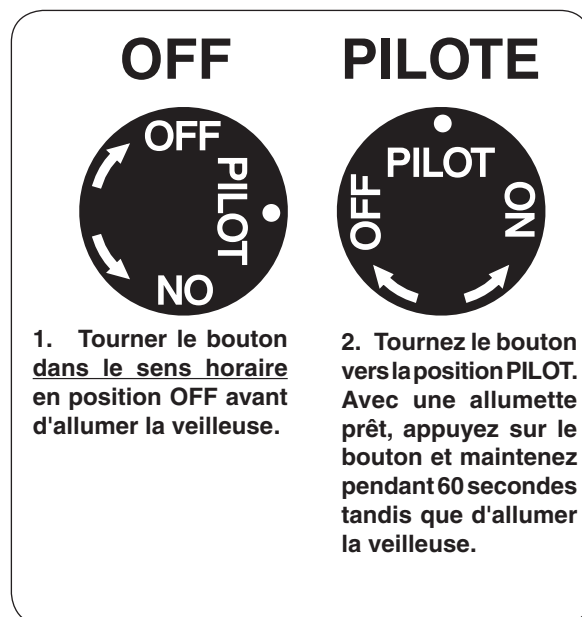

**Fig. 28-1** Détail bouton de commande (OFF, PILOTE)

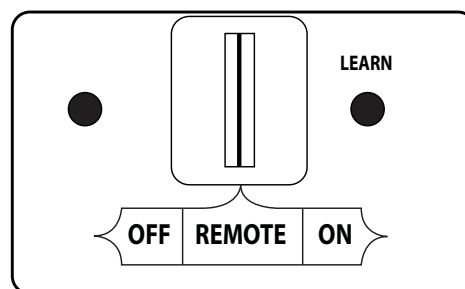

**Fig. 28-2** Détail récepteur de télécommande (REMOTE)

2. Locate the remote transmitter and press and hold the **ON/HI** button (see Fig. 29-1). The ignition sequence will begin.

**Note:** Continue holding the button to increase the flame. A click will be heard when max flame height is reached.

**Note:** Upon initial use or after an extended period of no use, the **ON/HI** button may have to be pressed for up to 3 seconds prior to functioning.

The remote receiver will emit an audible "beep"; then the valve will automatically open and the burner will light. Adjust to the desired setting(s) with the remote transmitter. See the REMOTE OPERATING INSTRUCTIONS section for details.

**Note:** The ignition sequence will take approximately 5 seconds.

**WARNING: If the burner fails to light within 5 seconds, press and hold the OFF button on the remote transmitter and/or slide the switch to the OFF position. Allow five (5) minutes for any gas in the unit to dissipate, then repeat steps 1 and 2 above. IF YOU SMELL GAS, SEE STEP B AT BEGINNING OF LIGHTING INSTRUCTIONS.**

If the burner fails to light after several tries, turn all system components to **OFF** and contact a qualified professional service technician.

## MANUAL LIGHTING

1. Ensure the pilot is burning. Then locate the 3-position switch on the remote receiver (see Fig. 29-2), and slide the switch to the **OFF** position.
2. Turn the gas control knob counterclockwise to **ON** (Fig. 29-3) to ignite the burner. The valve will open and the burner will light.

**Note:** The ignition sequence will take approximately 5 seconds.

**WARNING: If the burner fails to light within 5 seconds, turn the control knob clockwise to PILOT. Allow five (5) minutes for any gas in the unit to dissipate, then repeat step 2 above. IF YOU SMELL GAS, SEE STEP B AT BEGINNING OF LIGHTING INSTRUCTIONS.**

If the burner fails to light after several tries, push in the control knob slightly and turn clockwise to **OFF**, and contact a qualified professional service technician.

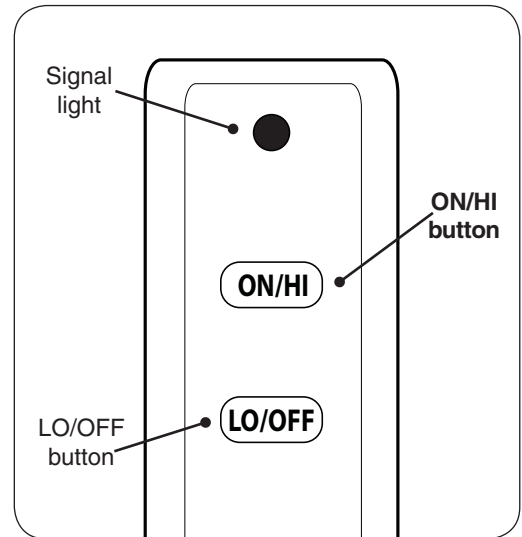

Fig. 29-1 Remote transmitter detail

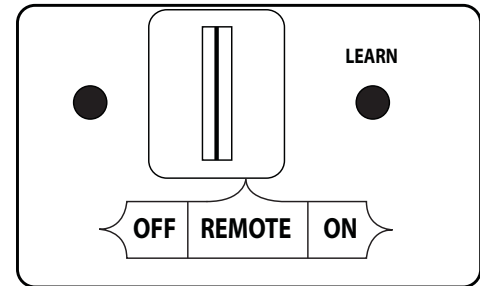

Fig. 29-2 Remote receiver (OFF for Manual Light)



Fig. 29-3 Control knob detail (ON)

2. Localiser la télécommande et appuyez sur le touche **ON/HI** (voir Fig. 30-1). La séquence d'allumage commence.

**Note:** Continuez à maintenir le touche pour augmenter la flamme. Un clic se fait entendre lorsque la hauteur max de flamme est atteinte.

**Note:** Dès la première utilisation ou après une longue période de non utilisation, le touche **ON/HI** peut être pressée pour 3 secondes avant de fonctionnement.

Le récepteur de la télécommande émettra un «bip» sonore, puis la vanne s'ouvre automatiquement et le brûleur s'allume. Choisissez le réglage souhaité(s) avec la télécommande. Voir la section INSTRUCTIONS DE FONCTIONNEMENT A DISTANCE pour plus de détails.

**Note:** La séquence d'allumage dure environ 5 secondes.

**WARNING:** Si le brûleur ne s'allume pas dans les 5 secondes, appuyez et maintenez le bouton OFF de la télécommande et / ou faites glisser le commutateur à la position OFF. Permettre aux cinq (5) minutes pour tout gaz dans l'unité à se dissiper, puis répétez les étapes 1 et 2 ci-dessus. **SIVOUS UNE ODEUR DE GAZ, voir l'étape B AU DÉBUT DE DIRECTIVES D'ALLUMAGE.**

Si le brûleur ne s'allume pas après plusieurs essais, tournez tous les composants du système à **OFF** et contactez un technicien qualifié.

## ALLUMAGE MANUEL

1. Assurer la veilleuse est allumée. Ensuite, localisez le commutateur à 3 positions sur le récepteur de la télécommande (voir Fig. 30-2), Et faites glisser le commutateur sur la position **OFF**.

2. Tournez le bouton de contrôle du gaz dans le sens antihoraire sur **ON** (Fig. 30-3) pour allumer le brûleur. La vanne s'ouvre et le brûleur s'allume.

**Note:** La séquence d'allumage dure environ 5 secondes.

**WARNING:** Si le brûleur ne s'allume pas dans les 5 secondes, tournez le bouton de commande vers la droite pour **PILOT**. Permettre aux cinq (5) minutes pour tout gaz de l'unité de dissiper, puis répétez l'étape 2 ci-dessus. **SIVOUS UNE ODEUR DE GAZ, voir l'étape B AU DÉBUT DE instructions d'allumage.**

Si le brûleur ne s'allume pas après plusieurs tentatives, appuyez sur le bouton de commande et tournez légèrement à **OFF** et contactez un technicien qualifié.

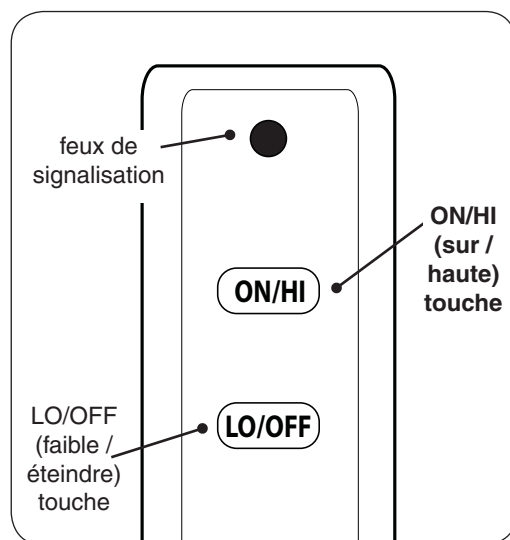

Fig. 30-1 Détail télécommande

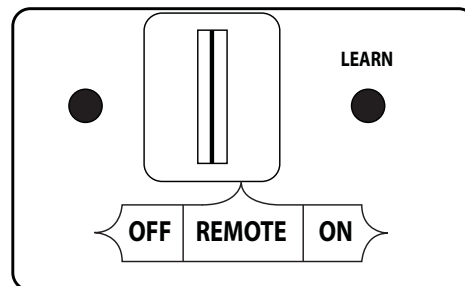

Fig. 30-2 Récepteur de la télécommander (OFF pour Light Manuel)



Fig. 30-3 Détail bouton de commande (SUR)

## SHUTTING DOWN

### **MAIN BURNER ONLY (pilot will remain lit):**

For remote shut down, press and hold the **LO/OFF** button on the remote transmitter until the burner shuts off. **If remote is unavailable**, slide the switch on the receiver to the **OFF** position. For manual shutdown, turn the control knob clockwise to **PILOT**.

### **BURNER AND PILOT (total shutdown):**

If you do not plan on using your burner system for an extended period (one week or more), **you may extinguish the pilot**. This will conserve energy and save you money.

Push in the control knob slightly and turn clockwise to **OFF**.

## PILOT BURNER CHECK/ADJUSTMENT

With the pilot burner lit and the control knob in the pilot position, check the pilot system for proper flame size and appearance (see Fig. 31-1). The pilot adjustment screw is located on the front of the gas valve (see Fig. 31-1). Using a small flat head screwdriver, adjust the pilot screw to properly size the flames. Turning the screw clockwise will lower the flames, and turning it counterclockwise will raise them. Be careful not to back the screw out of its threads.

The pilot flame should be a quiet, soft blue flame with yellow tipping that encircles the thermocouple tip.

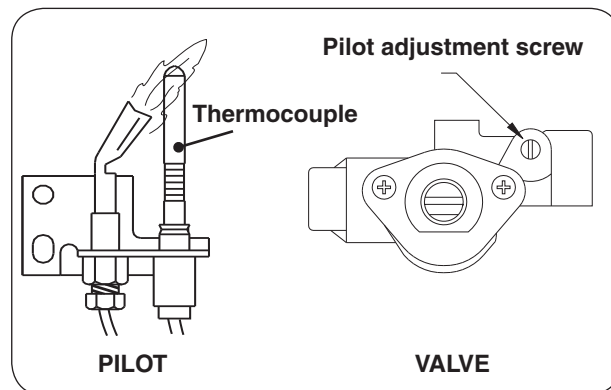

**Fig. 31-1** Pilot adjustment detail

# REMOTE OPERATING INSTRUCTIONS - 17 SERIES

## ORIENTATION

**Note:** If the remote does not function, and batteries with an adequate power level are installed, refer to the SYNCING THE REMOTE section.

Prior to remote transmitter use, light the appliance per the REMOTE LIGHTING section. Familiarize yourself with the transmitter buttons, as illustrated in Fig. 31-2.

Identify the transmitter buttons:

- **ON/HI BUTTON:** This button turns the burner ON (when the pilot is lit), and increases the flame height.
- **LO/OFF BUTTON:** This button decreases the flame height and turns the burner OFF (pilot will remain lit).

## FLAME HEIGHT

The flame height may be adjusted via the remote transmitter. Press and hold the **ON/HI** button to increase the flame height. Press and hold the **LO/OFF** button to decrease the flame height. A click will be heard when the max/minimum setting is reached.

**Note:** Continuing to hold the **LO/OFF** button will turn off the burner. The pilot will remain lit.

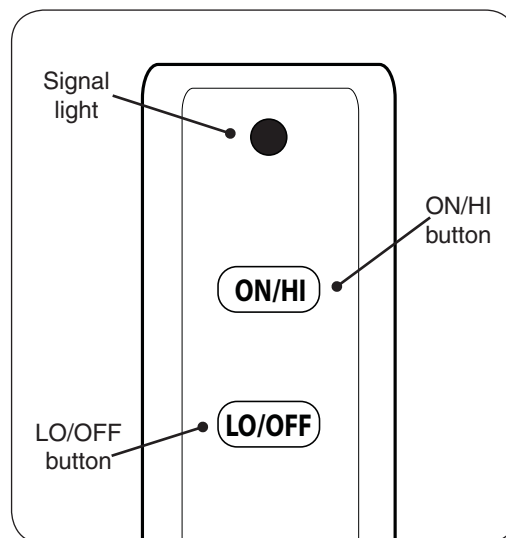

**Fig. 31-2** Remote transmitter detail

## FERMER

### BRÛLEUR SEULEMENT (pilote reste allumé):

Pour arrêt à distance, appuyez et maintenez le bouton **LO / OFF** sur la télécommande jusqu'à ce que le brûleur est éteint. Si la télécommande n'est pas disponible, faites glisser le commutateur sur le récepteur à la position **OFF**. Pour un arrêt manuel, tournez le bouton de commande vers la droite pour **PILOT**.

### BRÛLEUR ET LA VEILLEUSE (arrêt total):

Si vous ne prévoyez pas d'utiliser votre système de brûleur pour une longue période (une semaine ou plus), vous pouvez éteindre le pilote. Ce sera de conserver l'énergie et économiser de l'argent.

Appuyer sur le bouton de commande légèrement et tournez dans le sens horaire sur **OFF**.

## VEILLEUSE CONTROLE/REGLAGE

Avec le brûleur de la veilleuse allumée et le bouton de commande dans le poste de pilotage, vérifier le système de pilotage de la taille de la flamme correspondant et l'apparence (voir Fig. 32-1). La vis de réglage de la veilleuse se trouve sur la face de la soupape à gaz (voir Fig. 32-1). L'aide d'un petit tournevis à tête plate, ajustez la vis de la veilleuse pour dimensionner correctement les flammes. Tourner la vis dans le sens horaire réduira les flammes, et en tournant dans le sens antihoraire leur suscitera. Veillez à ne pas desserrer la vis de ses fils.

La flamme de la veilleuse devrait être tranquille, flamme bleu pâle avec des pointes jaunes qui entoure la pointe du thermocouple.

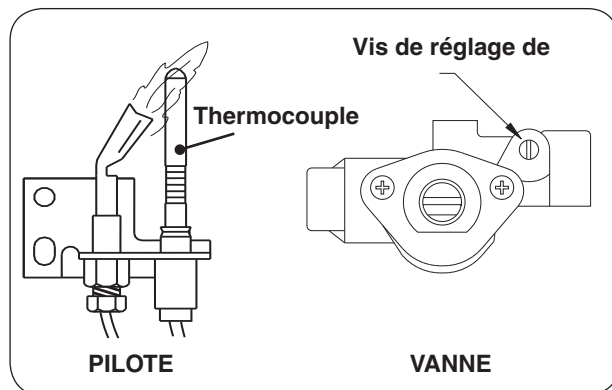

Fig. 32-1 Détail réglage de la veilleuse

## MODE D'EMPLOI À DISTANCE - 17 SÉRIE

### ORIENTATION

Si la télécommande ne fonctionne pas, et des batteries avec un niveau de puissance adéquate sont installés, reportez-vous à la synchronisation des section REMOTE.

Avant l'utilisation de télécommande, allumer l'appareil par la section de distance de l'éclairage. Familiarisez-vous avec les touches de l'émetteur, comme illustré sur la Fig. 32-2.

Identifier les touches de l'émetteur:

- **TOUCHE ON/HI:** Ce touche active le brûleur ON (lorsque le pilote est allumé), et augmente la hauteur de la flamme.
- **TOUCHE LO/OFF:** Cette touche permet de diminuer la hauteur des flammes et éteindre l'brûleur (pilote reste allumé).

### HAUTEUR DE LA FLAMME

La hauteur de flamme peut être ajustée via la télécommande. Appuyez et maintenez enfoncé le touche **ON/HI** pour augmenter la hauteur de la flamme. Appuyez et maintenez le touche **LO/OFF** pour diminuer la hauteur des flammes. Un clic se fait entendre lorsque le réglage max / minimum est atteint.

**Note:** En continuant à maintenir le touche **LO/OFF** permet d'éteindre le brûleur. Le pilote restera allumé.

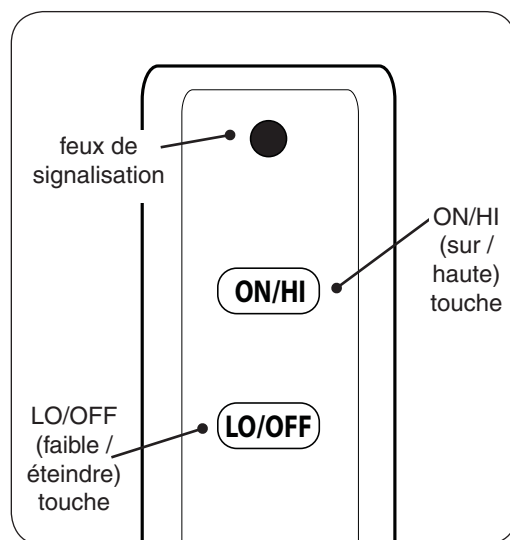

Fig. 32-2 Détail télécommande



## CLEANING AND SERVICING

**Note:** Servicing may be necessary to ensure proper pilot operation and proper burn characteristics.

Always shut off the gas to the appliance while performing service work.

Allow the appliance to cool before servicing.

**Installation, service, and repair must be done by an NFI Certified or other qualified professional service technician. The appliance should be examined before use, and must be inspected at least annually to prevent burner shutdown, sooting, odors, etc. It must be checked for clean burning operation and proper pilot appearance, with the correct tools to service this unit. More frequent servicing may be required.** It is imperative that all control components and compartments, burner(s), air shutters, and circulating air passageways of the appliance be kept clean and free of all obstructions (as applicable).

In addition, a periodic examination and cleaning of the solid-fuel-burning fireplace venting system should be conducted by a qualified professional service technician.

**Any safety screen or guard removed for servicing must be replaced prior to operating this appliance.**

Verify proper operation after servicing.

If, after a period of use, the flames start to exhibit unusual shapes and behavior, or the burners fail to ignite smoothly, the burner may require cleaning or servicing. If this happens, it is recommended to contact the nearest dealer to get the appliance serviced.

**Do not remove the rating plates or the warning tags. These are an integral safety and identification component of this appliance.**

**We recommend following these instructions at the beginning of each fireplace season and as needed throughout the year, depending on your usage pattern and the environmental conditions in your home. More frequent cleaning and maintenance may be necessary when burning propane gas than with natural gas.**

### SYNCING THE REMOTE SYSTEM (if applicable)

Ensure the burner system is off and completely cool.

Locate the 3-position switch on the remote receiver and slide it to the **REMOTE** position. Use the tip of a pen or a wire clip to push the **LEARN** button and release. See Fig. 34-1. A beep will be heard. Then press and hold the **ON** or **ON/HI** button on the remote transmitter; a series of beeps should be heard. The remote system is now synced. Refer to the LIGHTING INSTRUCTIONS to test.

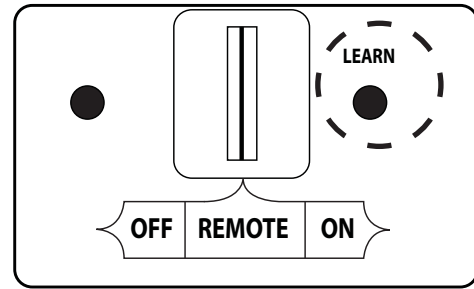

Fig. 34-1 Remote receiver sync detail

## FLAME DESCRIPTION

Observe the flames. The flames should be blue at the base and a combination of blue/yellow at the body and at the tips. The flames should be approximately 5-8" above the log set/spheres/glass, with the center flame being the tallest. (See 34-2 for example.)

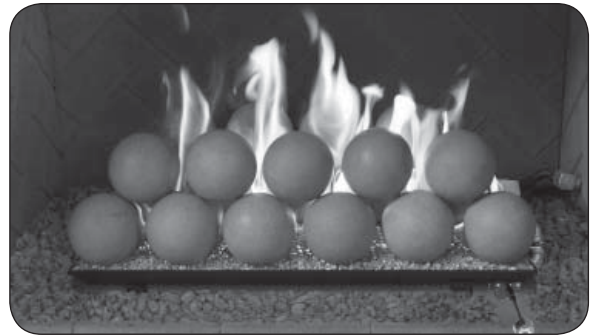

Fig. 34-2 Flame appearance

## TROUBLESHOOTING

POSSIBLE CAUSE	SOLUTIONS
<b>1 BURNER SHUTTING DOWN DURING OPERATION</b>	
<b>A.</b> Insufficient or excessive gas pressure	<b>A1.</b> Check gas pressure (Read D- F. of IMPORTANT PRE-INSTALLATION AND FIREPLACE SAFETY INFORMATION section, & check with local gas company). <b>A2.</b> Other gas appliances may be on the same gas line, dropping gas pressure to burner system. Check pressures with everything operating to ensure adequate pressure.
<b>B.</b> Log or sphere placement (if applicable)	<b>B.</b> For Fyre Spheres, reference the FYRE SPHERE PLACEMENT section in this manual for recommended sphere positioning. For log sets, reference the separate instructions included with the log set.
<b>C.</b> Flue area, fireplace, or damper dirty from soot	<b>C.</b> Clean around, above, and under damper thoroughly. Clean fireplace, removing loose material, including soot and creosote.
<b>D.</b> Fireplace too small for unit	<b>D.</b> Ensure minimum requirements are met. (See SPECIFICATIONS section in this owner's manual.)
<b>E.</b> Pilot flame lifting off thermocouple/generator	<b>E.</b> Check gas pressure (see section A1).
<b>F.</b> Pilot (remote compatible)	<b>F.</b> Contact your dealer for instructions on replacement.
<b>G.</b> Blockages on burner	<b>G.</b> Vacuum any lava granules or material that may have fallen onto burner pipe area.
<b>2 PILOT WILL NOT LIGHT</b>	
<b>A.</b> Pilot flame lifting off thermocouple/generator	<b>A.</b> Check gas pressure (see Section 1, A1 of this table).
<b>B.</b> Gas supply off/manual shutoff valve closed	<b>B.</b> Turn on gas supply or open manual shutoff valve.
<b>C.</b> Air in gas line	<b>C.</b> Bleed the gas supply line and repeat LIGHTING INSTRUCTIONS until air is removed.
<b>D.</b> Pilot hood blocked	<b>D.</b> Check for debris or dirt / Clean pilot
<b>3 LOW FLAME HEIGHT</b>	
<b>A.</b> Gas pressure	<b>A.</b> Check gas pressure (see Section 1, A1 of this table).
<b>4 BURNER NOT BURNING EVENLY</b>	
<b>A.</b> Burner orifice clogged	<b>A.</b> Clean burner orifice.
<b>5 ODORS</b>	
<b>A.</b> Gas leak	<b>A.</b> Shut off gas, if possible. Follow instructions on front page. Have a qualified professional installer or the gas company correct all leaks.
<b>B.</b> New home, new carpet, or new paint	<b>B.</b> When these odors are drawn into the fireplace, this may cause objectionable odors. Thoroughly ventilate the area before restarting your burner system.
<b>C.</b> Damper closed	<b>C.</b> Ensure that damper is open.

## TROUBLESHOOTING (Cont.)

POSSIBLE CAUSE	SOLUTIONS
----------------	-----------

**6**

### SOOTING

Due to the design of this burner system, sooting will occur on the log set or Fyre spheres. This is a result of the yellow flame generated by the burner and is normal. If sooting occurs in the firebox or in the room, refer to the information below:

<b>A.</b> Insufficient or excessive gas pressure	<b>A.</b> Check gas pressure (see Section 1, A1 of this table).
<b>B.</b> Drafts in room	<b>B.</b> Eliminate drafts by closing heating and air conditioning vents, returns, and outside air vents. Fans blowing directly into fireplace should be turned off when system is operating.
<b>C.</b> Air shutters blocked (if applicable)	<b>C.</b> Air shutters are blocked with debris. Vacuum debris away from air shutter.
<b>D.</b> Log set or sphere placement (if applicable)	<b>D.</b> See solution in Section 1, B.
<b>E.</b> Using a product other than Real Fyre glass/gems with burner	<b>E.</b> Make sure only Real Fyre glass/gems are used with your burner.
<b>F.</b> Using natural-gas burner on propane gas or propane burner on natural gas	<b>F.</b> If the gas listed on the nameplate does not match the gas you are burning, shut down the burner system immediately. Then call your dealer.
<b>G.</b> Adding any accessories to burner systems	<b>G.</b> Shut down burner system and take off any logs, spheres, or accessories that do not belong with the system.

**7**

### PILOT WILL NOT STAY LIT

<b>A.</b> Valve won't hold	<b>A.</b> Contact your dealer for instructions on replacement.
<b>B.</b> Pilot hood not aimed at thermocouple	<b>B.</b> Pilot hood bent; replace pilot or angle pilot hood properly so pilot flame hits thermocouple.
<b>C.</b> Pilot line bent / kinked at connection to valve	<b>C.</b> Replace pilot line.
<b>D.</b> Thermocouple is loose	<b>D.</b> Tighten thermocouple nut at gas control valve. (Do not overtighten.)
<b>E.</b> Thermocouple cracked or worn out	<b>E.</b> Replace thermocouple.
<b>F.</b> Excessive down draft	<b>F.</b> Install chimney cap / Outside chimney too close to other peaks / Check chimney flue for proper height / Poorly designed chimney

**8**

### BURNER WILL NOT TURN ON

<b>A.</b> Low/dead batteries in remote transmitter AND/OR remote receiver (select models only)	<b>A.</b> Replace batteries as needed (if applicable).
--	--

Please use this page to record any information that you may want to have at hand.

# WARRANTY

## PETERSON VENTED DECORATIVE GAS APPLIANCE LIMITED WARRANTY

Robert H. Peterson Co. ("RHP") warrants your Real Fyre® vented decorative gas appliance to be free from defects in material and workmanship.

Peterson vented ceramic refractory gas logs are warranted for **as long as you own them (lifetime)**.

Peterson vented burner assemblies are **WARRANTED for TEN (10) YEARS**. Peterson vented outdoor stainless-steel burner assemblies are warranted for **FIVE (5) YEARS**.

Peterson glass, gems, nuggets, and fiber-ceramic blend gas logs are warranted for **FIVE (5) YEARS**.

SPK-26 controls are warranted for **THREE (3) YEARS**.

APK-17 controls (including -17 valve) are warranted for **TWO (2) YEARS**.

All other Peterson valves, pilots, and controls are warranted for **ONE (1) YEAR (excluding batteries)**.

### A COPY OF YOUR SALES SLIP FOR PROOF OF PURCHASE IS REQUIRED

This warranty applies to the original purchaser for products which are installed in the United States or Canada and which are operated and maintained as intended for single family residential usage. This warranty is valid only with proof of purchase, shall commence on the date of purchase, and shall terminate (both as to original and any replacement products) on the anniversary date of the original purchase of the product stated on the above schedules.

This warranty covers defects in material and workmanship. This warranty **does not** cover parts which become defective as a result of negligence, misuse, use not in compliance with the Owner's Manual/Installation Instructions, accidental damage, improper handling, improper storage, improper installation, **lack of required routine maintenance** (as specified in the Owner's Manual/Installation Instructions), electrical damage, local gas impurities or failure to protect against combustibles. Product must be installed (and gas must be connected) as specified in the Owner's Manual/Installation Instructions by a **qualified professional installer**. Modifications to products which are not specifically authorized will void this warranty. Accessories, parts, valves, remotes, etc. when used must be Peterson products or this warranty is void. Warranted items will be repaired or replaced at Peterson's sole discretion. This warranty **does not** apply to rust, corrosion, oxidation, or discoloration unless the affected part becomes inoperable.

This warranty **does not** cover labor or labor related charges, except as provided by separate specific written programs from the Peterson Co. All repair work must be performed by a qualified professional service person and requires prior approval of Peterson.

Peterson may require the defective product or part to be returned to the factory to determine the cause of failure. Peterson will pay freight charges if the product or part is determined to be defective. This warranty does not cover breakage in shipment from our (Independent) distributor to its customer if the damage is determined to have occurred during that shipment.

This warranty specifically excludes liability for **indirect, incidental, or consequential** damages. Some states and provinces do not allow the exclusion or limitation of incidental or consequential damages, so the above exclusion may not apply to you. This warranty gives you specified legal rights, and you may have other rights that vary from state to state or province.

For additional information regarding this warranty, or to place a warranty claim, contact the R. H. Peterson dealer where the product was purchased.

When contacting your Peterson dealer or the R. H. Peterson Co., please provide the following information:

- Your name, address, telephone number, e-mail
- Sales receipt showing where purchased and date purchased
- Model number, serial number of product, date code
- Relevant information: installer, additions, repairs, when defect was first noted

**TO REGISTER YOUR PRODUCT ONLINE GO TO: WWW.RHPETERSON.COM,  
AND CLICK ON PRODUCT REGISTRATION. THANK YOU FOR YOUR PURCHASE.**

### FOR USE IN THE COMMONWEALTH OF MASSACHUSETTS

**INSTALLATION OF THIS APPLIANCE MUST BE IN COMPLIANCE WITH 248 CMR: BOARD OF STATE EXAMINERS OF PLUMBERS AND GAS FITTERS AND PERFORMED BY A MASSACHUSETTS LICENSED PLUMBER OR GAS FITTER ONLY.**

**CONNECTOR KITS USED FOR INSTALLATION AND OPERATION OF THIS APPLIANCE MUST NOT BE MORE THAN 36" IN LENGTH.**

**FIREPLACE DAMPER MUST BE REMOVED OR PERMANENTLY FIXED/WELDED IN FULL OPEN POSITION PRIOR TO INSTALLING THIS PRODUCT.**

### Quality Check

Date: \_\_\_\_\_

<b>Burner Orifices</b>	Nat.	L.P.	<b>Leak Test:</b> _____	<b>Model#:</b> _____
<b>Main:</b>	_____	_____	<b>Burn Test:</b> _____	<b>Serial#:</b> _____
<b>Other:</b>	_____	_____	<b>Gas Type:</b> <u>Nat. / L.P.</u>	<b>Air Shutter:</b> _____
				<b>Inspector:</b> _____