

ROBERT H. PETERSON CO.

Instructions

Real Fyre®

Hand-Crafted Gas Logs Since 1949

Models:

- MPEC-24-10(M)(P)
- MPEC-30-10(M)(P)
- MPEC-36-10(M)(P)
- MPEC-48-10(M)(P)
- MPEC-60-10(M)(P)

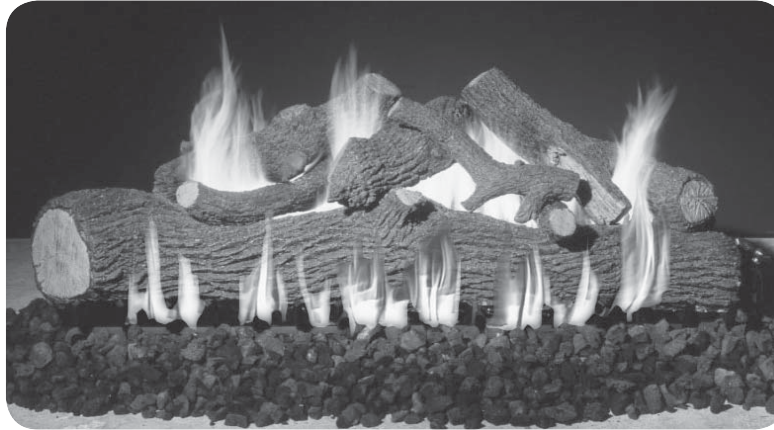

With Safety Pilot System and remote control

EPIC BURNER GAS LOG SET

⚠ WARNING

If the information in this manual is not followed exactly, a fire or explosion may result, causing property damage, personal injury, or loss of life.

Do not store or use gasoline or other flammable vapors and liquids in the vicinity of this or any other appliance.

WHAT TO DO IF YOU SMELL GAS:

- Open a window.
- Do not try to light any appliance.
- Do not touch any electrical switch; do not use any phone in the building.
- Immediately call the gas supplier from a neighbor's phone and follow the gas supplier's instructions.
- If you cannot reach the gas supplier, call the fire department.

Installation and service must be performed by an NFI Certified or other qualified professional installer, service agency, or the gas supplier.

INSTALLER & CONSUMER:

These instructions MUST be retained with this appliance.

IMPORTANT: READ THESE INSTRUCTIONS CAREFULLY BEFORE STARTING INSTALLATION OF YOUR LOG SET

The Peterson Real-Fyre® gas log set is to be installed only in a solid-fuel burning fireplace with a working flue constructed of noncombustible material. Solid-fuels shall not be burned in a fireplace where this gas log set is installed. The installation, including provisions for combustion, ventilation air, and required minimum permanent vent opening, must conform with the *National Fuel Gas Code (ANSI Z223.1/NFPA 54)* and applicable local building codes. In Canada, the installation must conform with the *Natural Gas and Propane Storage and Handling Installation Code (CSA-B149.1)*. A damper clamp is included to maintain the minimum permanent vent opening and to prevent full closure of the damper blade. **The chimney damper should be fully opened when burning the log set. The log set is designed to burn with yellow flames; thus adequate ventilation is absolutely necessary.**



We recommend that our gas hearth products be installed and serviced by professionals who are certified in the U.S. by the National Fireplace Institute® (NFI) as NFI Gas Specialists.

Important: For safe operation and proper performance of this product and to comply with certification, listings, and building code acceptances, use ONLY Peterson Real-Fyre® controls, parts, and accessories that have been specifically listed or certified for use with this burner system. Use of other controls, parts, or accessories is prohibited and will void all warranties, certifications, listings, and building code approvals, and may cause property damage, personal injury, and loss of life.

ROBERT H. PETERSON CO. • 14724 East Proctor Avenue, City of Industry, CA 91746

Table of Contents

SUBJECT	PAGE
Parts List (24" - 30" models)	3
Parts List (36" - 60" models)	4
Fireplace Requirements	5
Minimum Free Opening Area of Chimney Damper	6
Installing the Damper Clamp	6
Installation	7
Installing and Testing the Burner	7
Checking and Adjusting the Pilot	7
Adjusting Air Mixers	7
Placing the Logs	7
Placing the Decorative Lava Rock	7
Log Placement	8
Log Placement (cont.)	9
Lighting and Operating Instructions	10
Lighting the Pilot	10
Maintaining the Pilot	10
Safety Pilot System	10
Maintenance and Service	11
Maintenance	11
Service	11
Flame Appearance	11
Troubleshooting	11
Warranty	12

Parts List (24" - 30" models)

Before beginning installation, be sure the gas log set is complete by comparing its contents with this Parts List. Parts may differ depending upon the size of the set purchased. Be sure you know the model number and size of your set when ordering replacement or optional parts and accessories.

24" models

Item No.	Part No.	Description
1.	EC-24-10(M)(P)	Valve, Pilot, Burner assembly
2.	RR-1A	Remote kit (not in 'M' units)
3.	CK-5-24SP	Connector kit
4.	DC-1	Damper clamp
5.	OCC-10	Lava Rock (qty of 3)
6.	MPL-22BR	Mammoth Pine rear bottom log 22"
7.	MPL-24BF	Mammoth Pine front bottom log 24"
8.	MPL-15T	Mammoth Pine top log 15"
9.	MPL-20T	Mammoth Pine top log 20"
10.	MPL-17T	Mammoth Pine top log 17"
11.	BL-13T	Mammoth Pine top log 13"

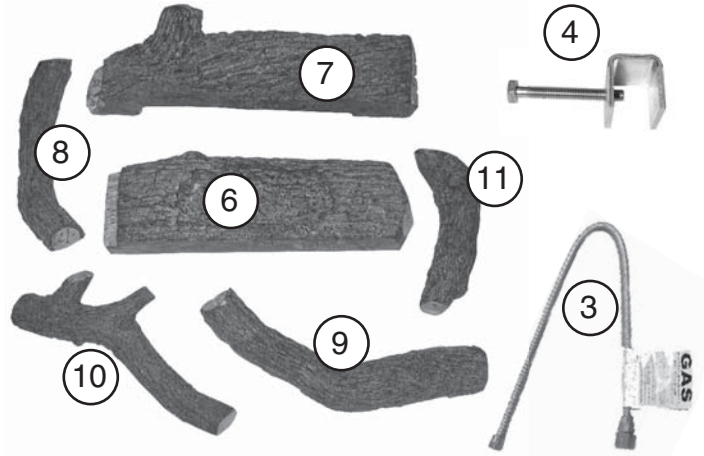
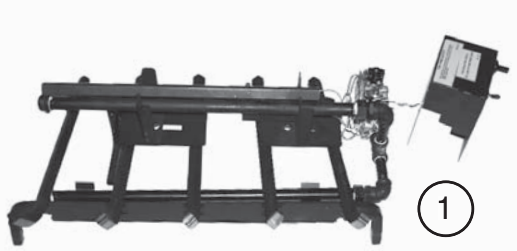

Photos not to scale.

Contact your local Real-Fyre® dealer for replacement parts and accessories.

30" models

Item No.	Part No.	Description
1.	EC-30-10(M)(P)	Valve, Pilot, Burner assembly
2.	RR-1A	Remote kit (not in 'M' units)
3.	CK-5-24SP	Connector kit
4.	DC-1	Damper clamp
5.	OCC-10	Lava Rock (qty of 4)
6.	MPL-24BR	Mammoth Pine rear bottom log 24"
7.	MPL-30BF	Mammoth Pine front bottom log 30"
8.	MPL-18T	Mammoth Pine top log 18"
9.	MPL-18TY	Mammoth Pine top log 18"
10.	MPL-20T	Mammoth Pine top log 20"
11.	MPL-17T	Mammoth Pine top log 17"

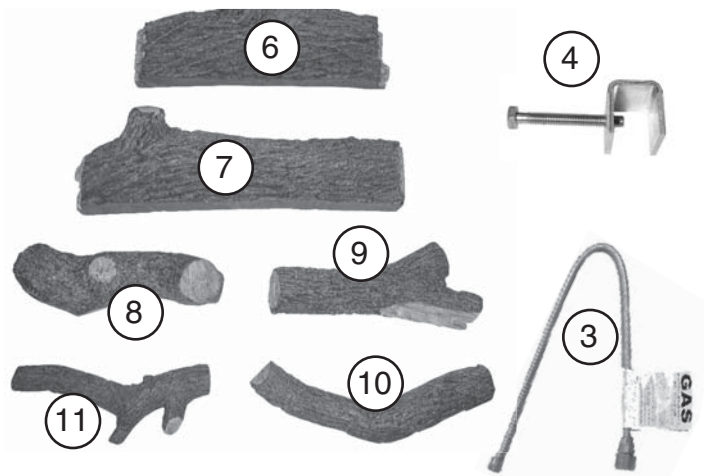
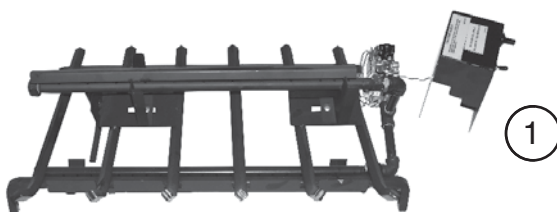

Photos not to scale.

Contact your local Real-Fyre® dealer for replacement parts and accessories.

Parts List (36" - 60" models)

Before beginning installation, be sure the gas log set is complete by comparing its contents with this Parts List. Parts may differ depending upon the size of the set purchased. Be sure you know the model number and size of your set when ordering replacement or optional parts and accessories.

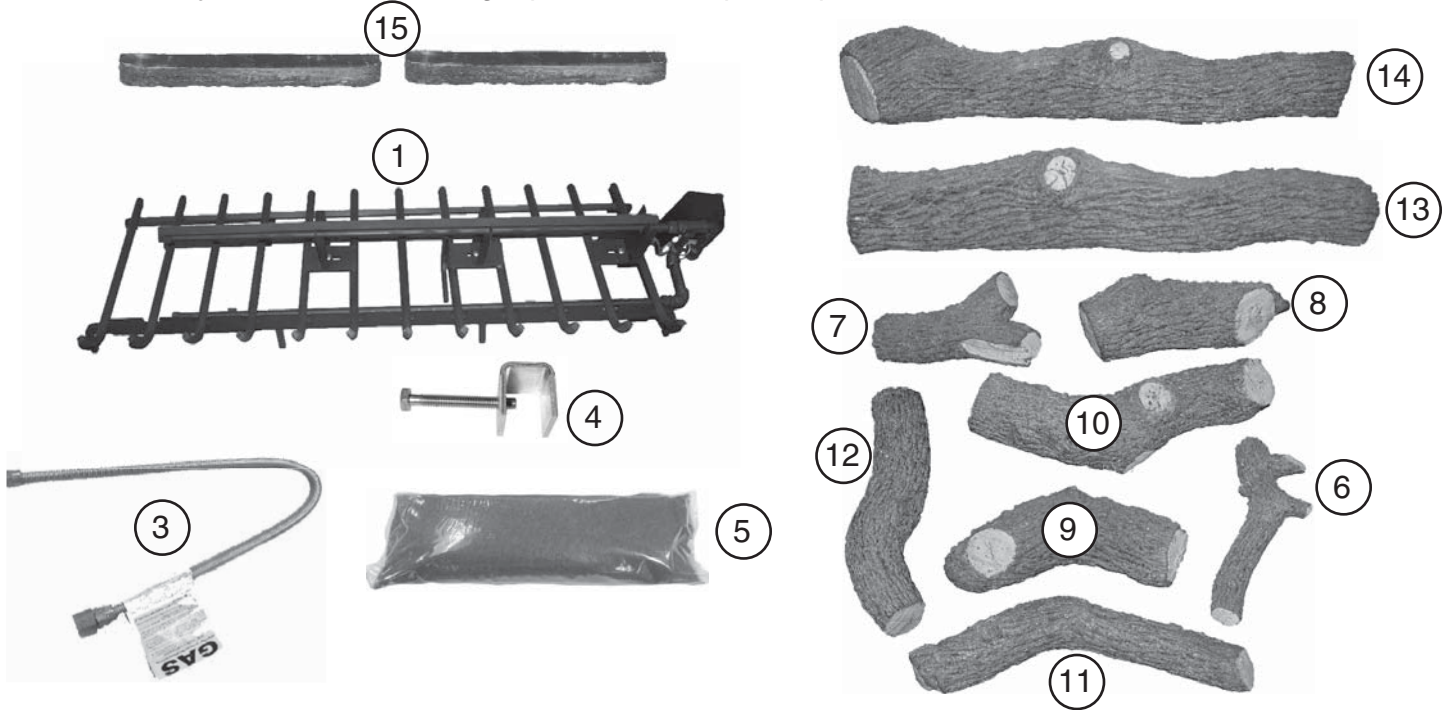

Item No.	Part No.	Description	60	48	36
1.	EC- 60 -10M(P)	Valve, Pilot, Burner assembly	x	x	x
2.	RR-1A	Remote kit (not in 'M' units)	x	x	x
3.	CK-5-24SP or CK-5-18SP	Connector kit Connector Kit	x	x	x
4.	DC-1	Damper clamp	x	x	x
5.	OCC-10	Lava Rock (see right for qty)	6	5	4
6.	MPL-17T	Mammoth Pine top log 17"	x	x	x
7.	MPL-18TY	Mammoth Pine top 'Y' log 18"	x	x	x
8.	MPL-18T	Mammoth Pine top log 18"	x	x	
9.	MPL-19T	Mammoth Pine top log 19"	x	x	
10.	MPL-20T	Mammoth Pine top log 20"	x	x	
11.	MPL-21T	Mammoth Pine top log 21"	x		x
12.	MPL-24T	Mammoth Pine top log 24"	x	x	x
13.	MPL- 36 BF or MPL- 48 BF or MPL- 60 BF	Mammoth Pine front bottom log 36" Mammoth Pine front bottom log 48" Mammoth Pine front bottom log 60"	x	x	x
14.	MPL- 30 BR or MPL- 42 BR or MPL- 48 BR	Mammoth Pine rear bottom log 30" Mammoth Pine rear bottom log 42" Mammoth Pine rear bottom log 48"	x	x	x
15.	LS-0006 or LS-0005	24" Rear spacer log (2) 20" Rear spacer log (2)	x	x	

MP-60 shown.
Logs 8-11 and 15 are not included with all sets.
Photos not to scale.



Contact your local Real-Fyre® dealer for replacement parts and accessories.

Note: Values in ***bold italics*** change with burner size and model log set.

Important Pre-installation Information

Check to be sure the fireplace meets venting and construction requirements for the installation of the Real-Fyre® gas log set (see FIREPLACE REQUIREMENTS section, below).

This burner may only be connected to the gas type listed on the label. Never use propane gas in a log set designed for natural gas or natural gas in a log set designed for use with propane gas.

Be sure the gas log set is properly sized for the fireplace. Improper sizing may negatively impact the proper drafting of the fireplace. Additionally, too large a log set will adversely affect the burn and hamper the proper operation of the control system. Fig. 5-1 illustrates the critical dimensions of the firebox.

This gas log set must be installed by an NFI Certified or other qualified professional installer. The installation, including provisions for combustion and ventilation air, must conform with local codes, or, in the absence of local codes, with the latest edition of the *National Fuel Gas Code, ANSI Z223-1*, and *NFPA54*.

Keep the appliance area clear and free from combustible materials, gasoline, and other flammable vapors and liquids.

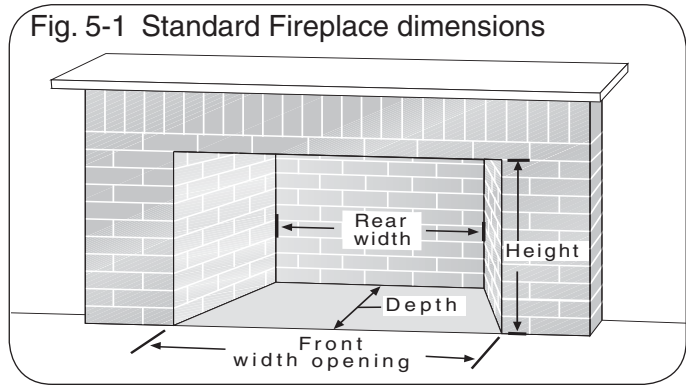

Note: It is recommended that complete firebox dimensions be obtained to ensure proper sizing.

Model no.	Min. Fireplace Size				BTU* (x 1000)	Orifice drill size (top/front)	
	Width		Depth	Height		Nat.	LP
	Front	Rear					
MPEC-24-10	34"	30"	20"	26"	60	28/48	47/56
MPEC-30-10	40"	36"	20"	30"	84	19/41	40/55
MPEC-36-10	48"	44"	28"	36"	100	13/33	36/47
MPEC-48-10	60"	56"	28"	36"	145	2/29	30/42
MPEC-60-10	72"	68"	28"	36"	260	none	22/29

*Nominal BTU based on gas inlet pressure. Nominal gas inlet pressure for natural gas is 5" W.C..

Important: To comply with building code acceptances, and for safe operation and proper performance of this log set, use ONLY Peterson Real-Fyre® parts and accessories. Use of other controls, parts, and accessories which are not designed for use with Real-Fyre® gas log sets is prohibited and will void all warranties, certifications, listings, and building code approvals, and may cause property damage, personal injury, or loss of life.

Fireplace Requirements

The Real-Fyre® gas log is to be installed only in a fully vented, fireplace with an open damper. The chimney must be free of any obstructions. The fireplace must be designed and approved to burn wood. The fireplace flue must be at least 8" at its smallest dimension.

The fireplace must have a gas supply line that has been installed by a qualified technician in accordance with all local codes. The gas supply line must be ½" minimum interior diameter. If the gas line to the fireplace is longer than 5', a larger diameter line may be necessary.

Be sure to clean the fireplace floor of any ashes or other foreign materials. It is recommended that the fireplace and chimney be inspected by a chimney sweep or other qualified person before you install the Real-Fyre® gas log set.

Required Gas Pressure: The minimum inlet gas supply pressure for the purpose of input adjustment is 5" of water column (w.c.) for natural gas. The maximum

inlet gas supply pressure is 10.5" w.c. for natural gas. The minimum inlet gas supply pressure for the purpose of input adjustment is 11" of water column (w.c.) for propane gas. The maximum inlet gas supply pressure is 13" w.c. for propane gas.

Testing the Gas Supply System: The gas log set and its individual shut-off valve must be disconnected from the gas supply piping system while performing any tests of the piping system at pressures in excess of ½ psig. The gas log set must be isolated from the gas supply piping system by closing its individual manual shut-off valve during any pressure testing of the gas supply piping system at test pressures equal to or less than ½ psig. This is accomplished by closing the gas supply line valve required by NFPA 54. A fireplace screen must be in place when the appliance is in operation and, unless other provisions are provided, the screen shall have an opening(s) for introduction of combustion air. **When glass fireplace doors are used, operate the gas log set with the doors open.**

Minimum Free Opening Area of Chimney Damper

Minimum Free Opening Area of Chimney Damper for Venting

For Factory Built Fireplaces Log Set Sizes						For Masonry Built Fireplaces Log Set Sizes				
Chimney Height	24"	30"	36"	48"	60"	24"	30"	36"	48"	60"
15'	38 sq. in.	53 sq. in.	63 sq. in.	91 sq. in.	163 sq. in.	42 sq. in.	57 sq. in.	67 sq. in.	95 sq. in.	167 sq. in.
20'	34 sq. in.	48 sq. in.	56 sq. in.	82 sq. in.	146 sq. in.	38 sq. in.	52 sq. in.	60 sq. in.	87 sq. in.	150 sq. in.
25'	32 sq. in.	45 sq. in.	53 sq. in.	77 sq. in.	138 sq. in.	-	-	-	-	-
30'	31 sq. in.	43 sq. in.	50 sq. in.	73 sq. in.	130 sq. in.	35 sq. in.	47 sq. in.	54 sq. in.	77 sq. in.	134 sq. in.

Note: The minimum chimney height from hearth to top of chimney is 15'.

Installing the Damper Clamp

A damper clamp (See **Parts List**) is provided as a means to prevent full and/or accidental closure of the fireplace damper when installed as illustrated (Fig. 6-2). **When the gas log set is operating, the damper must be fully open.** To install the damper clamp:

1. Open the fireplace damper.
2. Place the damper clamp (Fig. 6-1) over the damper blade as in Fig. 6-2.
3. Tighten the set screw of the damper clamp with pliers or a wrench so that it affixes to the damper blade. The clamp must be permanently installed.

4. Should the damper clamp not fit, install a permanent damper stop or provide some other means of preventing full and/or accidental closure of the damper such as removing the damper blade.

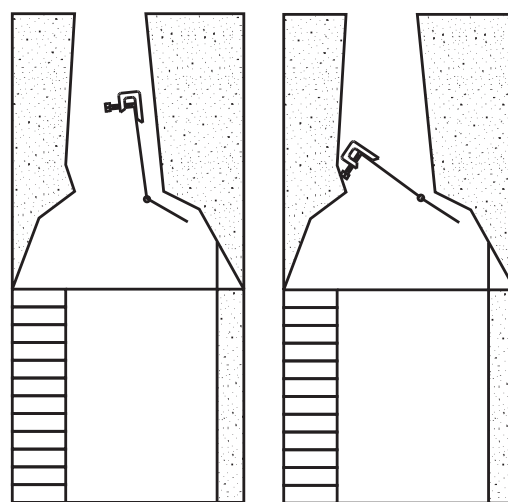
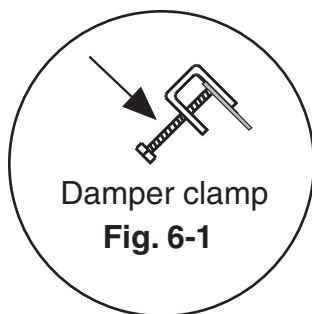

Open

Closed

Fig. 6-2

Installation

Installing and Testing the Burner

1. Connect the gas flexible connector to the gas stub from the fireplace wall.
2. Place the assembled burner and grate into the center of the firebox.
3. Connect the other end of the gas flex connector to the burner valve.
4. Check for leaks.

CAUTION: CHECK ALL CONNECTIONS FOR GAS LEAKS USING A HALF-AND-HALF SOAPY WATER SOLUTION. IF A LEAK IS DETECTED TIGHTEN CONNECTIONS AND TEST AGAIN. **NEVER USE AN OPEN FLAME TO CHECK FOR GAS LEAKS.**

5. Place the heat shield over the valve.

Checking and Adjusting the Pilot

1. The pilot flame should encircle the generator tip which is preset at the factory (Fig. 7-2). Ordinarily, the pilot will not require field adjustment.
2. If adjustment is necessary, remove the cap screw (Fig. 7-1) and turn the smaller gas adjustment screw inside counterclockwise to increase the pilot flame and clockwise to decrease the pilot flame. Replace cap screw.

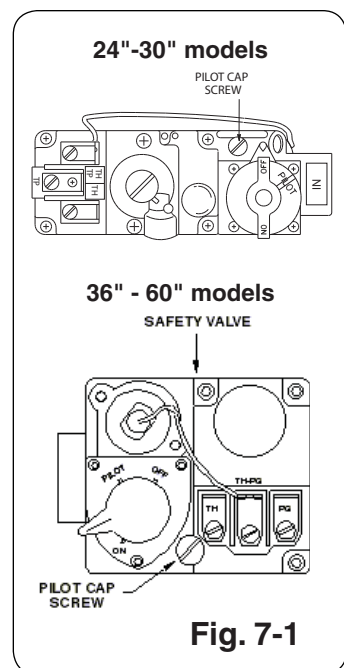

Fig. 7-1

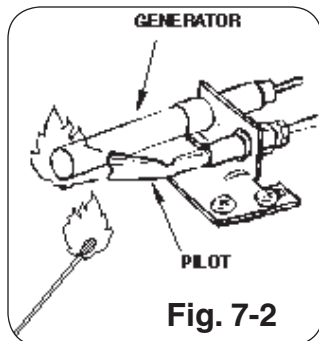

Fig. 7-2

Note: Pilot flame should encircle top of the generator.

Adjusting Air Mixers

Burners are equipped with air mixers for the upper (except 60") and front burners. Adjust the size and color of the flame by opening (turn outward) or closing (turn inward) as shown in Fig. 7-3, 4.

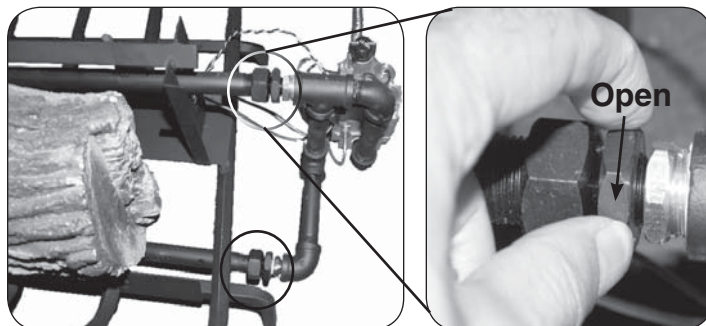

Fig. 7-3

Fig. 7-4

Placing the Logs

CAUTION: Logs are heavy! Safely moving the front or back logs requires two or more people (see Fig. 8-3)

1. Place the spacer logs about six inches apart on either side of center and just forward of the rear legs (Fig. 8-1, 60" and 48" units only). Then rest the back bottom log on top of the two spacer logs as far forward (against the center burner) as possible without touching the pilot. The flat side should be down and the heat chambers facing the back of the fireplace.
2. Place the front log on the grate in front of the burner pipe with the flat down and the heat chambers toward the burner pipe and the log as far forward as possible while keeping the back parallel with the burner pipe (Fig 8-3).
3. Place top logs across the front and back logs in the order and positions shown for your particular log set size on p. 8-9.

Placing the Decorative Lava Rock

Locate the bag of lava rock and pour its contents around the base of the grating in an attractive pattern. Do not place the Lava Rock on the logs or grate.

Log Placement

Note: Reference the Parts List on page 4 for Figures 8-1 thru 9-2.

Fig. 8-1 The rear spacer logs provide a platform for rear bottom log

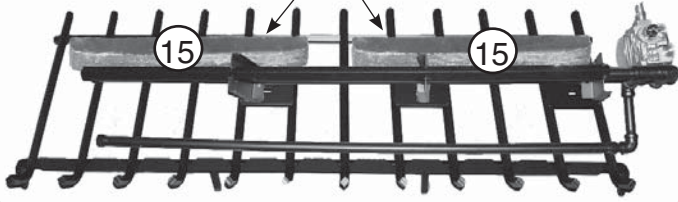

Place the burner system and rear spacer logs

Fig. 8-2

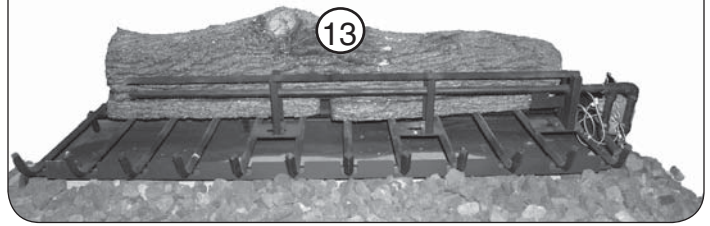

Place back bottom log (requires two to lift)

Fig. 8-3

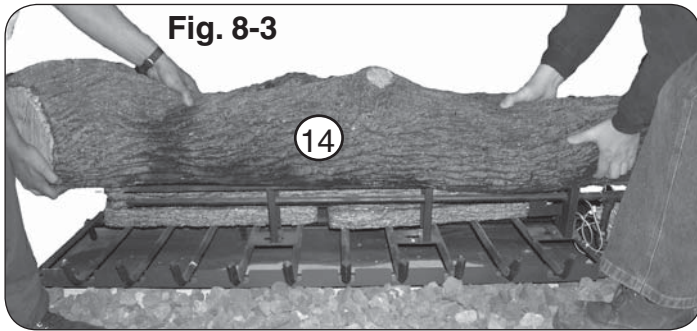

Place front bottom log (requires at least two to lift)

Fig. 8-4

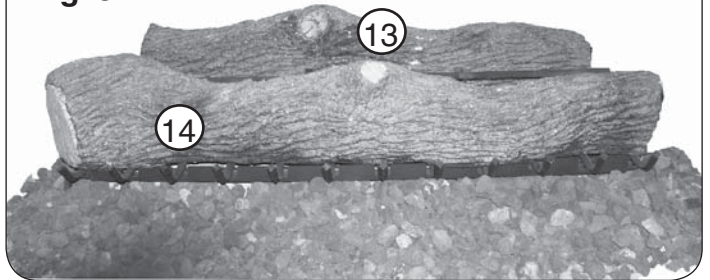

Bottom logs in place

Fig. 8-5

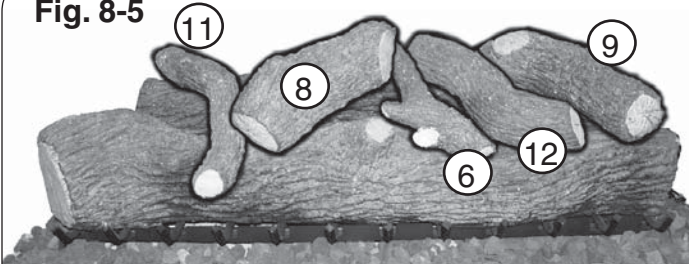

60" setup A

Fig. 8-6

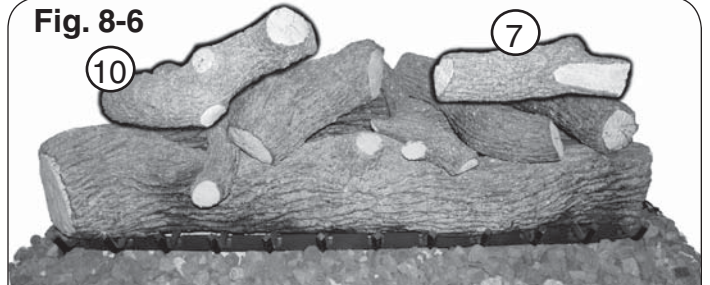

60" setup B

Fig. 8-7

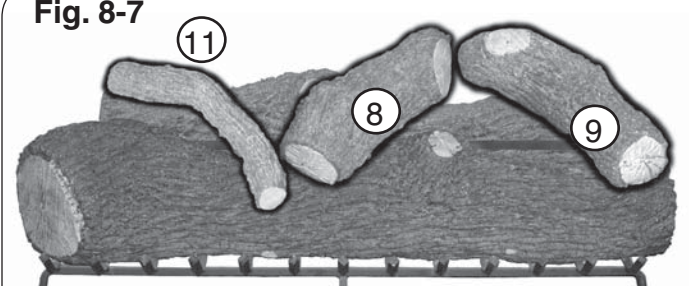

48" setup A

Fig. 8-8

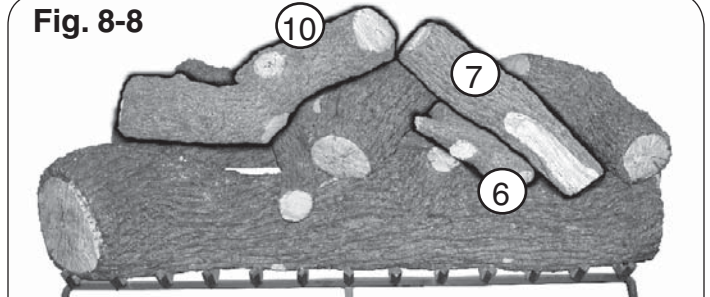

48" setup B

Log Placement (cont.)

Fig. 9-1

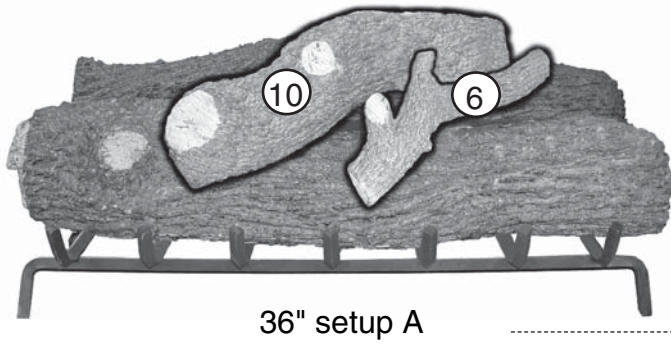
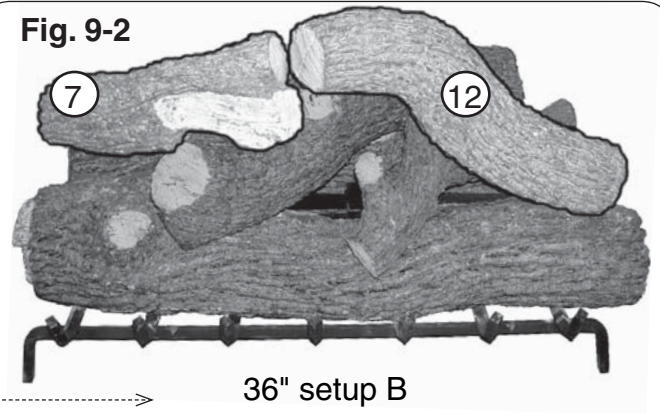

Fig. 9-2



Note: Reference the Parts List on page 5 for Figures 9-3 thru 9-6.

Fig. 9-3

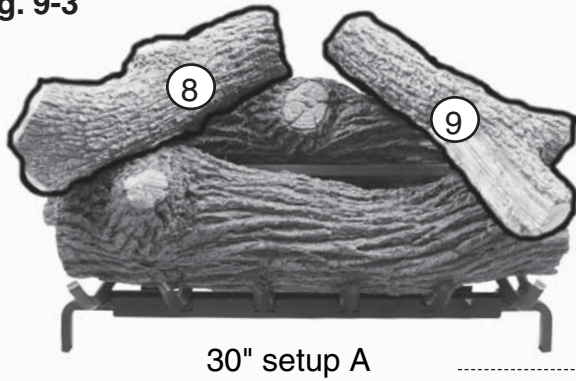

Fig. 9-4

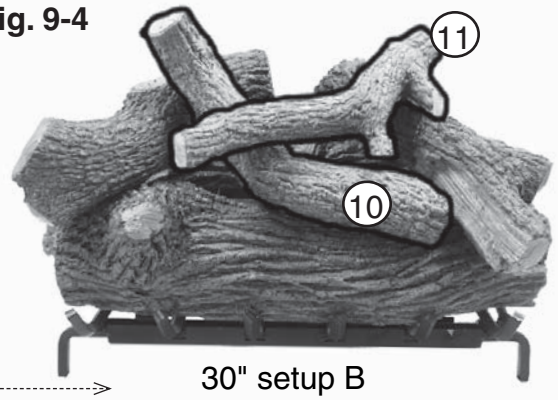

Fig. 9-5

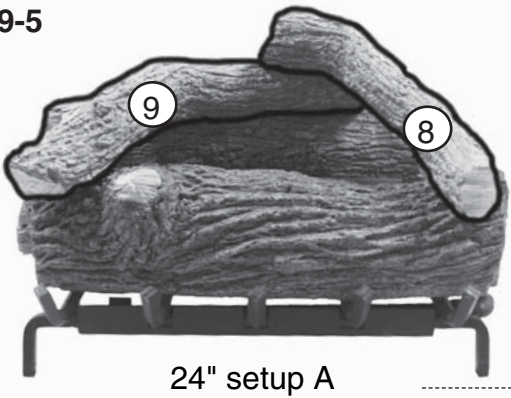
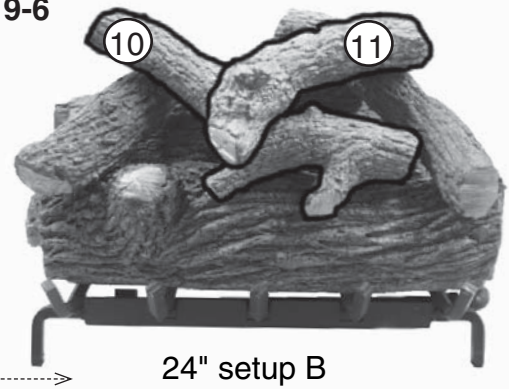

Fig. 9-6



Lighting and Operating Instructions

FOR YOUR SAFETY, READ BEFORE LIGHTING

WARNING: If you do not follow these instructions exactly, a fire or explosion may result causing property damage, personal injury or loss of life.

Do not use this appliance if any part has been underwater. Immediately call for a qualified professional service technician to inspect the appliance and to replace any part of the control system and any gas control which has been under water.

The Real-Fyre burner system has a pilot which can be lit by hand using a match or lighter. When lighting the pilot, follow these instructions exactly.

BEFORE LIGHTING, smell all around the burner area for gas. Be sure to smell next to the floor as some gas is heavier than air and will settle on the floor. IF YOU SMELL GAS, FOLLOW THE INSTRUCTIONS ON THE COVER (P. 1).

Lighting the Pilot

To light the pilot, make sure the toggle switch is in the **OFF (DOWN)** position. Rotate the safety valve knob counterclockwise to the **PILOT** position. Push the safety valve knob fully in and at the same time place a long match or a butane lighter at the pilot burner. The pilot will light. Hold the safety valve knob in for approximately 60 seconds. If the pilot does not stay lit, turn the safety valve knob to the **OFF** position. Wait five minutes and repeat the lighting instructions. If the pilot still fails to stay lit see the **Troubleshooting** section.

Lighting and Extinguishing the Burner System

To turn on your gas log set with the pilot lit, turn the safety valve knob to the **ON** position. Switch the toggle switch control to the on (UP) position and the gas log set will light.

To turn off your gas log set, switch the toggle switch control to the off (DOWN) position. The pilot will remain lit. See the instructions that came with the remote kit (if purchased) for remote lighting instructions.

To turn off the pilot, be sure the toggle switch control is off (DOWN) and depress and turn the safety valve knob to the **OFF** position.

Maintaining the Pilot

Your log set is equipped with a safety pilot that will shut off the gas supply in case the pilot is not burning or functioning properly. Verify that the generator spade clips are tightly connected to the terminal screws on the valve and the pilot is adjusted properly with the pilot flame hitting the generator as shown in Fig. 10-2 If the pilot will not stay lit, call your local gas utility or gas supplier.

Cleaning and Checking

A periodic check of the following should be performed at least annually by a qualified professional service representative.

1. Proper operation of valves and switches.
2. Flue system for proper venting.
3. Damper operation
4. Orifices for dirt or other foreign matter.
5. Visual check on the burner.
6. Air mixers for dust/lint blockage.
7. Excessive soot on logs.

Safety Pilot System

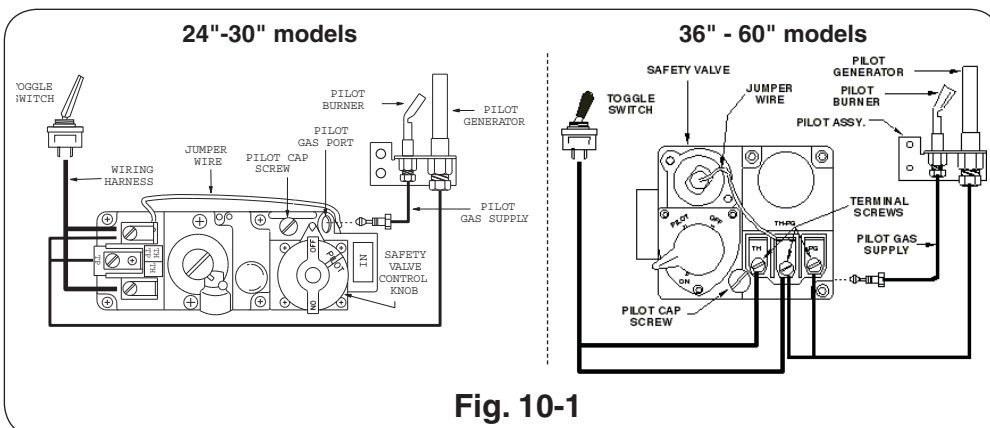

Fig. 10-1

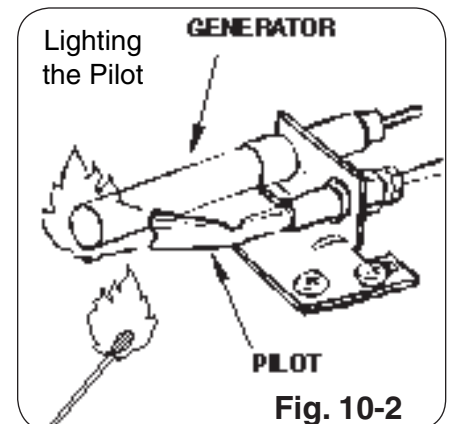

Fig. 10-2

Note: Pilot flame should encircle top of the generator.

Maintenance and Service

Maintenance

Once installed and operating properly, the Real-Fyre® gas log set requires very little maintenance. You should inspect the log set and control annually for the following:

1. **Excessive Sooting** - Some sooting of the log set is normal and adds to the natural appearance of burned wood. If soot accumulates, you may brush the soot off with a stiff brush. Logs may also be cleaned by allowing them to heat up, then spraying them with water where soot has accumulated.
2. **Debris around the control** - Inspect the control and pilot to be sure it is free of any dirt or debris.
3. **Insects and burner blockage** - Check the burner ports and the air-mixer, if present, to make sure they are free from debris. Blocked burner ports and orifices may result in poor flame

distribution or flame at air-mixer (if equipped). Reference SOLUTION, to symptoms 2-4, of **Troubleshooting**.

Service

It is recommended that a qualified professional service technician be called to service the gas log set and control should service be required. The **Troubleshooting** section of these instructions serves as a guide for ensuring optimum performance of the gas log set.

Flame Appearance

The flames should be blue at the base and a combination of blue/yellow at the body and tips.

Troubleshooting

PROBLEM	CAUSE	SOLUTION
1. Pilot will <u>not</u> stay lit	a. Pilot generator may not be producing sufficient millivoltage.	a. Check with a millivolt meter. Should be 250 millivolts or more.
	b. Pilot flame making a blowing sound	b. Pilot needs adjusting (See Pilot Adjustment).
	c. Generator wire leads attached to the wrong terminals on the valve.	c. Connect leads per wiring diagram, previous page
	d. Defective thermomagnet safety in valve.	d. Replace valve.
2. Pilot Burning. No Gas to Burner	a. Safety valve not turned to the ON position after lighting pilot.	a. Turn to ON position.
	b. Wire leads are not properly connected to valve or switch terminals	b. Attach all wire leads tightly to proper terminals (See wiring diagram, previous page).
	c. Voltage to pilot generator too low	c. See section 1a above.
	d. Defective valve.	d. Replace valve.
3. Log set Not burning properly	a. Low flame/uneven flame.	a. Check for low gas pressure; minimum operating pressures of 5" W.C. at manifold.
4. Log set will <u>not</u> shut OFF	a. Toggle Switch Control lead wires to the valve may be shorted together or on wrong terminals.	a. See wiring diagram, previous page. System takes 15-20 seconds to complete shutdown (nominal).
5. Frequent pilot outage	a. Pilot flame is out of adjustment.	a. See section 1b above.
	b. Down drafts from the chimney, extinguishing the pilot.	b. Check draft. Consult with a qualified chimney expert.
6. Log set shuts down during operation	a. Glass doors closed causing excessive heat buildup.	a. Open glass doors.
	b. Pilot generator improperly mounted on rear of burner pans.	b. See (Mounting Pilot Assembly to Real-Fyre® burners).
	c. Heat shield not in place.	c. Place heat shield over valve.
7. Excessive soot on logs	a. Yellow flame impingement	b. Open air shutter on front burner or main burner as needed.

WARRANTY

PETERSON VENTED GAS LOG SETS LIMITED WARRANTY

All Peterson gas logs are **WARRANTED for as long as you own them (lifetime)**.

All Peterson burner assemblies are **WARRANTED for TEN (10) YEARS**.

SPK-26 controls are covered by a **THREE (3) YEAR "All Parts" Warranty**.

All other Peterson valves, pilots, and controls are covered by a **ONE (1) YEAR Limited Warranty (excluding batteries)**.

PLEASE KEEP A COPY OF YOUR SALES SLIP FOR PROOF OF PURCHASE

This warranty applies to the original purchaser and to single family residential use only. It commences from date of purchase, and is valid only with proof of purchase.

This warranty does not cover parts becoming defective through misuse, accidental damage, electrical damage, improper handling, storage, and/or installation. Product must be installed (and gas must be connected) as specified in the instructions or operator's manual, by a **qualified professional installer**. Accessories, parts, valves, remotes, etc., when used must be Peterson Co. product.

This warranty **does not** apply to rust, corrosion, oxidation, or discoloration, unless the affected component becomes inoperable. It **does not** cover labor or labor-related charges.

This warranty specifically excludes liability for **indirect, incidental**, or consequential damages. Some states do not allow the exclusion or limitation of incidental or consequential damages, so the above exclusion may not apply to you. This warranty gives you specified legal rights, and you may have other rights that may vary from state to state.

For additional information regarding this warranty, or to place a warranty claim, contact the R.H. Peterson dealer where the product was purchased.

ROBERT H. PETERSON CO.

Quality Check

Date: _____

Orifice # (Main): _____

Orifice # (Other): _____

Leak Test: _____

Burn Test: _____

Gas Type: NAT. / PROPANE

Model #: _____

Serial #: _____

Air Shutter: _____

Inspector: _____