

Burner Systems:

- G31-18/20**
- G31-24/30**
- G31-33/39**

**For use with
 natural gas only**



**DESIGN CERTIFIED
 to
 Manually Lighted, Natural Gas
 Vented Decorative Appliance
 ANSI Z21.84-2012**

**FOR INSTALLATION IN
 SOLID-FUEL BURNING
 FIREPLACES***

G31 TRIPLE BURNER VENTED SYSTEMS (MANUALLY LIGHTED)

WARNING

If the information in this manual is not followed exactly, a fire or explosion may result, causing property damage, personal injury, or loss of life.

Do not store or use gasoline or other flammable vapors and liquids in the vicinity of this or any other appliance.

WHAT TO DO IF YOU SMELL GAS:

- **Open a window.**
- **Do not try to light any appliance.**
- **Do not touch any electrical switch; do not use any phone in the building.**
- **Immediately call the gas supplier from a neighbor's phone. Follow gas supplier's instructions.**
- **If you cannot reach the gas supplier, call the fire department.**

Installation and service must be performed by a qualified professional installer, service agency, or the gas supplier.

This appliance is only for use with the type of gas indicated on the rating plate.

IMPORTANT: READ THESE INSTRUCTIONS CAREFULLY BEFORE STARTING INSTALLATION OF THE UNIT.

The Real Fyre burner system is to be installed only in a solid-fuel burning fireplace with a working flue and constructed of noncombustible material. The installation, including provisions for combustion and ventilation air must conform with the *National Fuel Gas Code, ANSI Z223.1/NFPA 54*, or the *CSA B149.1, Natural Gas and Propane Installation Code*, and applicable local building codes.

A damper clamp is included to maintain the minimum permanent vent opening and to prevent full closure of the damper blade. **The chimney damper MUST be fully opened when burning the unit. The unit is designed to burn with yellow flames; thus adequate ventilation is absolutely necessary.**

To comply with certification, listings, and building code acceptances, and for safe operation and proper performance of this burner system, use ONLY Peterson parts and accessories. Use of other controls, parts, and accessories that are not designed for use with Real Fyre burner systems is prohibited and will void all warranties, certifications, listings, and building code approvals, and may cause property damage, personal injury, or loss of life. Peterson will not be liable for any damages caused by this misuse.

***Note:** Solid-fuels shall not be burned in a fireplace where a decorative appliance is installed.



**INSTALLER:
 Leave this manual with the appliance.
 CONSUMER:
 Retain this manual for future reference.**



12-086

TABLE OF CONTENTS

GETTING STARTED

IMPORTANT PRE-INSTALLATION AND FIREPLACE SAFETY INFORMATION	3
FIREPLACE OPERATING SAFETY INFORMATION	4
SPECIFICATIONS	5
DAMPER CLAMP INSTRUCTIONS	6
BURNER REPLACEMENT PARTS LIST	7
LOGS PARTS LIST	8

INSTALLATION

INSTALLATION	10
<i>BURNER INSTALLATION</i>	10
<i>LAVA GRANULES/COALS (DECORATIVE)</i>	11
<i>LOG SET AND EMBERS PLACEMENT [MC(O,S) log sets]</i>	12

USE, CARE, & SERVICE

LIGHTING INSTRUCTIONS	15
<i>FOR YOUR SAFETY, READ BEFORE LIGHTING</i>	15
<i>TO SHUT OFF GAS TO THE APPLIANCE</i>	15
CLEANING AND SERVICING	16
FLAME DESCRIPTION	16
TROUBLESHOOTING	17
WARRANTY	18

IMPORTANT PRE-INSTALLATION AND FIREPLACE SAFETY INFORMATION

- CAUTION:** Installation and repair must be done by an NFI Certified or other qualified professional installer.
- Installer:** Carefully read these instructions before installing this gas burner system. Be sure you understand all safety precautions and warnings contained in this manual.
- A. BE CAREFUL:** If not installed, serviced, and used correctly per these instructions, this product can cause serious personal injury, property damage, or loss of life.
- B. WARNING:** Before installing in a solid-fuel-burning fireplace, the chimney flue, damper, and firebox must be thoroughly CLEANED of soot, creosote, ashes, and loose paint, and must be inspected by a qualified chimney cleaner. Some older fireplaces may need repair prior to installing this appliance.
- C.** This appliance is only for use with the type of gas indicated on the rating plate. This appliance is **NOT FIELD CONVERTIBLE** for use with other gasses.
- CHECK GAS TYPE (natural): The gas supply must be the same as stated on your burner system rating plate. If gas supply is different, **DO NOT INSTALL**. Contact your dealer for immediate assistance.
- D. INSUFFICIENT GAS PRESSURE WILL KEEP THE UNIT FROM OPERATING PROPERLY. DO NOT USE IF GAS PRESSURE IS LOWER THAN THE MINIMUM REQUIREMENT.**
- E.** The minimum inlet gas supply pressure for purposes of input adjustment is **5"** water column (w.c.) on **natural gas**. Insufficient gas pressure will affect proper operation of the pilot (if equipped). Do not install this gas appliance if minimum pressure is not available. The maximum inlet gas supply pressure is 10.5" w.c. on natural gas. (Do not connect this appliance directly to a natural gas tank-this can cause an explosion.)
- F. The gas piping system must be sized to provide minimum inlet pressure at the maximum flow rate (BTU/hr).** Undue pressure loss will occur if the pipe is too small, or the run is too long. Gas supply pipe must be 1/2" minimum interior diameter. If the gas line is longer than 20', a larger diameter line may be necessary. Refer to the NFPA 54 guidelines for further details.
- G.** Input ratings shown in BTU per hour are for elevations up to 2,000 ft. For elevations above 2,000 ft., refer to the National Fuel Gas Code or contact manufacturer before installing this product.
- H.** This gas appliance and its main gas valve must be disconnected from the gas-supply piping system during any pressure testing of that system at test pressures in excess of 1/2 psig.
- I.** This gas appliance must be isolated from the gas-supply piping system by closing the equipment shutoff valve connected to the gas-supply line during any pressure testing of the gas-supply piping system at test pressures equal to or less than 1/2 psig.
- J. To install the gas appliance in your fireplace, the fireplace MUST meet the minimum size requirements (see product specifications table in SPECIFICATIONS section).**
- K.** This appliance may be installed in an aftermarket, permanently located, manufactured (mobile) home, where not prohibited by local codes. Installation of appliances designed for manufactured home (U.S. only) or mobile home installation must conform with the Standard *CAN/CSA Z240 MH, Mobile Housing*, in Canada, or with the *Manufactured Home Construction and Safety Standard, Title 24 CFR, Part 3280*, in the United States, or when such a standard is not applicable, *ANSI/NCSBCS A225.1/NFPA 501A, Manufactured Home Installations Standard*.
- L. DO NOT install this burner system if the fireplace hearth is recessed.** The fireplace floor must be at the same level as or higher than the fireplace front opening. If glass doors are used: the fireplace floor must not be blocked by the door frame; the frame must have openings to allow for fresh air circulation. See the SPECIFICATIONS section for details.

FIREPLACE OPERATING SAFETY INFORMATION

- A. Adults shall be present when this gas appliance is operating. This unit shall not be left burning when unattended or while anyone is sleeping.
- B. Keep the area of the gas burner system clear and free from combustible materials, gasoline, and other flammable vapors and liquids.
- C. DO NOT use this appliance if any part has been underwater. Immediately call a qualified service technician to inspect the appliance and to replace any part of the control system and any gas control that has been underwater. Attempted operation may result in fire or explosion resulting in property damage, personal injury or loss of life.
- D. **A fireplace screen must be in place when the system is burning.** Provisions for adequate combustion air must be maintained. Unless other provisions for combustion air are provided, the screen shall have an opening(s) for introduction of combustion air. Combustion air is adequate when all flames curl into the fireplace and away from the screen. **When a glass fireplace enclosure (door) is used, leave the doors fully open when the system is in operation.**
- E. Do not remove the rating plates or the warning tags. These are an integral safety and identification component of this appliance.
- F. Be sure to read the CLEANING AND SERVICING and FLAME DESCRIPTION sections.

SPECIFICATIONS

Real Fyre gas burner systems must be installed only in a wood burning fireplace with the minimum firebox dimensions and venting requirements met (see table on this page). This appliance is designed to burn with yellow flames; adequate ventilation is absolutely necessary.

Product Specifications

Burner Model	Dimensions				BTU Rating
	Width		Depth	Height	Nat. Gas
	Front	Rear			
G31-18/20 (18" log set)	25"	20"	15"	16"	55k
G31-24/30 (24" log set)	35"	25"	15"	16"	65k
G31-24/30 (30" log set)	39"	28"	15"	16"	65k
G31-33/39 (33" log set)	44"	32"	15"	16"	85k
G31-33/39 (39" log set)	47"	32"	15"	16"	85k

Note: Rear width is at corresponding depth.

Table 1 - Product Specifications

Fireplace Floor Requirement

DO NOT install this burner system if the fireplace hearth is recessed. The fireplace floor must be at the same level as or larger than the fireplace front opening. An ash lip or recess may not exceed $\frac{3}{4}$ ". See Fig. 5-1 below.

Note: If glass doors are used: the fireplace floor must not be blocked by the door frame; the frame must have openings to allow for fresh air circulation.

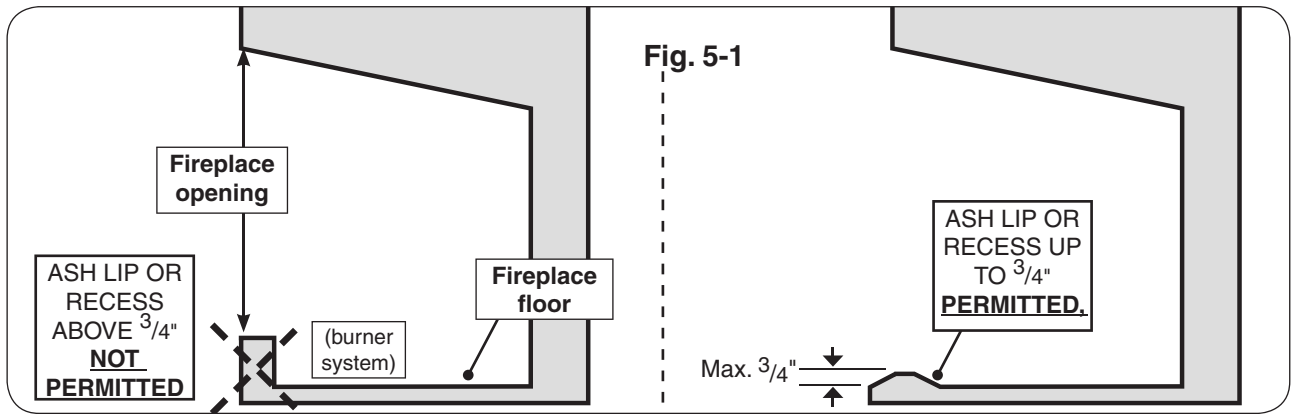

DAMPER CLAMP INSTRUCTIONS

The damper clamp with hex bolt (Fig. 6-1) is provided as a means to prevent full closure of the damper blade. The clamp is easily attached to most damper blades with pliers or a wrench, and must be permanently installed. The clamp is designed to prevent accidental closure of the damper when installed as illustrated (Fig. 6-2). Should the clamp not fit, or fail to provide the permanent vent opening listed in Table 2 below, have a permanent stop installed, remove the damper blade, or have the damper cut to provide the minimum permanent opening required.

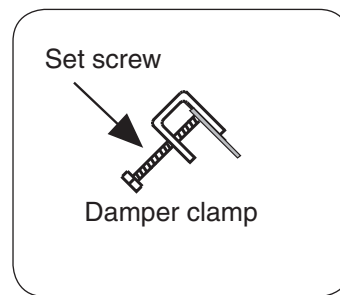

Fig. 6-1 Damper clamp detail

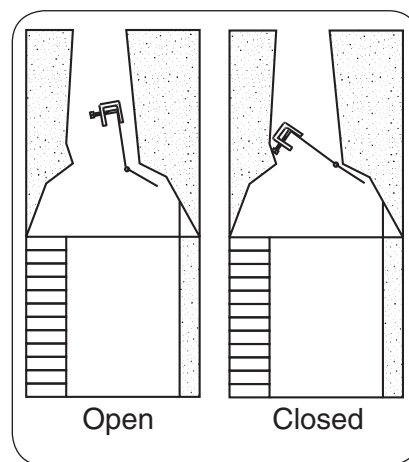

Fig. 6-2 Damper open / closed

Venting Requirements

Minimum permanent free opening area of chimney damper for venting (sq. in.)			
For factory-built fireplaces			
Chimney height	18/20"	24/30"	33/39"
15'	24	30	42
20'	20	25	35
30'	16	19	27
For masonry-built fireplaces			
15'	35	41	52
20'	32	37	47
30'	29	34	43

Table 2 - Minimum Chimney Damper Venting Requirements

Note: The minimum chimney height from hearth to top of chimney is 15'.

THESE ARE MINIMUM DAMPER OPENING SPECIFICATIONS.

THE DAMPER MUST BE COMPLETELY OPENED WHEN OPERATING THIS GAS APPLIANCE TO ACHIEVE THE BEST VENTILATION POSSIBLE.

BURNER REPLACEMENT PARTS LIST

Note: Photos not to scale

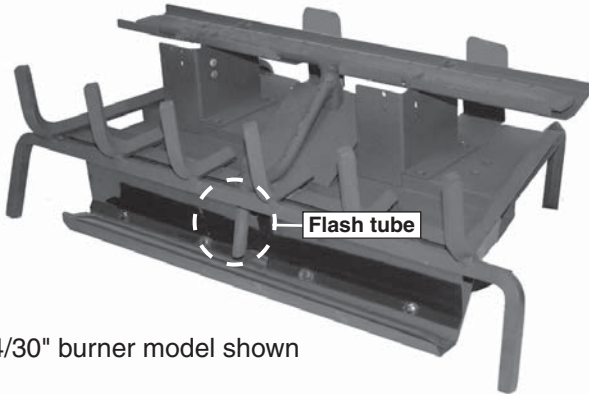

24/30" burner model shown

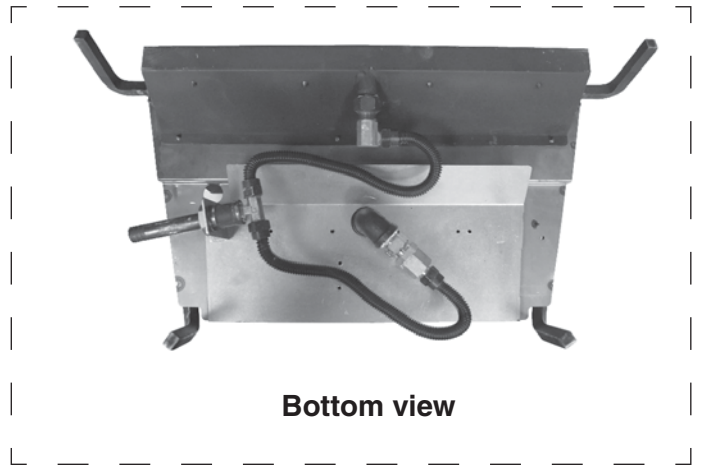

Bottom view

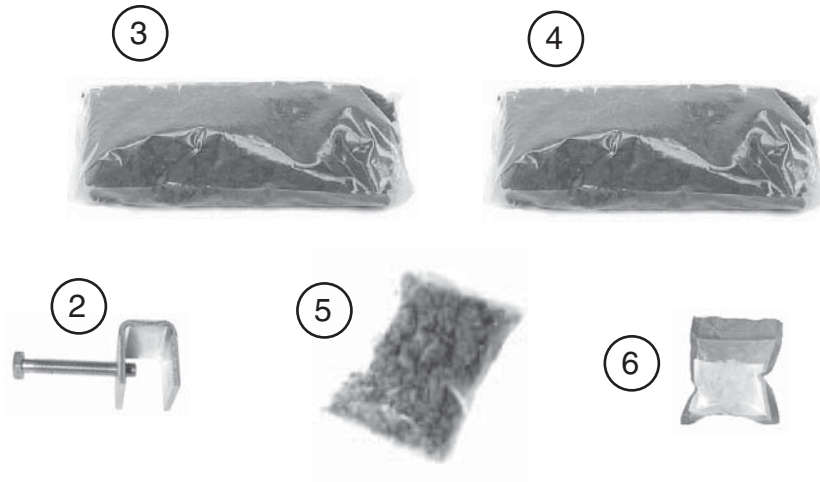
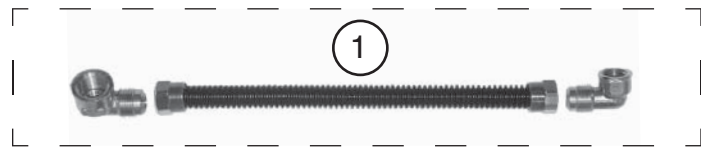

Replacement parts can be ordered from your local Real Fyre dealer.

Item	Description	18/20" model		24/30" model		33/39" model	
		Part No.	Qty.	Part No.	Qty.	Part No.	Qty.
1.	Flex connector (w/ adapters), 1/2" O.D. x 24"	CK-5-24SP	1	CK-5-24SP	1	CK-5-24SP	1
2.	Damper clamp	DC-1	1	DC-1	1	DC-1	1
3.	Lava fyre coals	LFC-6	1	LFC-6	1	LFC-6	1
4.	Lava granules	LF-5	1	LF-5	1	LF-5	1
5.	Glowing embers	EM-21B	1	EM-21B	2	EM-21B	3
6.	Bryte coals	EM-11	1	EM-11	1	EM-11	2

LOGS PARTS LIST

MC(O,S) log sets are designed exclusively for placement on G31 burner systems and are addressed in this manual.

Additional common log sets are available: CHB, CHD, CHAO, CHS, CHNA, CHNS series.

If a common log set is purchased, follow the supplied supplemental instructions.

MC(O,S)-18 Log Sets					
Item	Description	Mountain Crest Oak (MCO)		Mountain Crest Split (MCS)	
		Part No.	Qty.	Part No.	Qty.
1.	Rear log	MCOL-16BR	1	MCOL-16BR	1
2.	Front log	MCOL-18BF	1	MCSL-18BF	1
3.	Center middle log	MCOL-14TC	1	MCSL-14TC	1
4.	Left top log	MCOL-10TL	1	MCSL-10TL	1
5.	Right top log	MCOL-12TR	1	MCSL-12TR	1
6.	Center top log	MCOL-9T	1	MCSL-9T	1

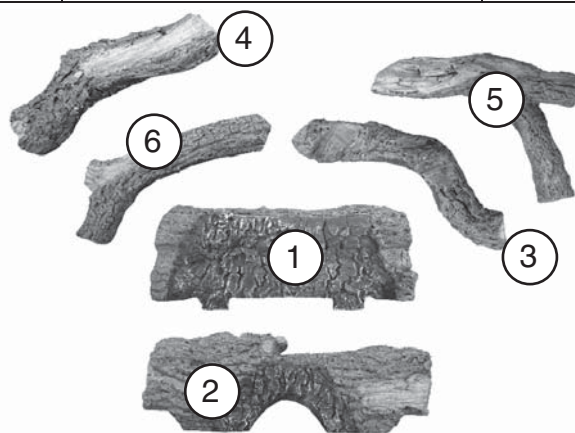

**MCO-18
Log Set Shown**

MC(O,S)-(24,30) Log Sets					
Item	Description	Mountain Crest Oak (MCO)		Mountain Crest Split (MCS)	
		Part No.	Qty.	Part No.	Qty.
1.	24" Rear log or 30" Rear log	MCOL-20BR MCOL-24BR	1 1	MCOL-20BR MCOL-24BR	1 1
2.	24" Front log or 30" Front log	MCOL-24BF MCOL-30BF	1 1	MCSL-24BF MCSL-30BF	1 1
3.	Center middle log	MCOL-14TC	1	MCSL-14TC	1
4.	Left top log	MCOL-11TL	1	MCSL-11TL	1
5.	Right top log	MCOL-15TR	1	MCSL-15TR	1
6.	Center top log	MCOL-10T	1	MCSL-10T	1

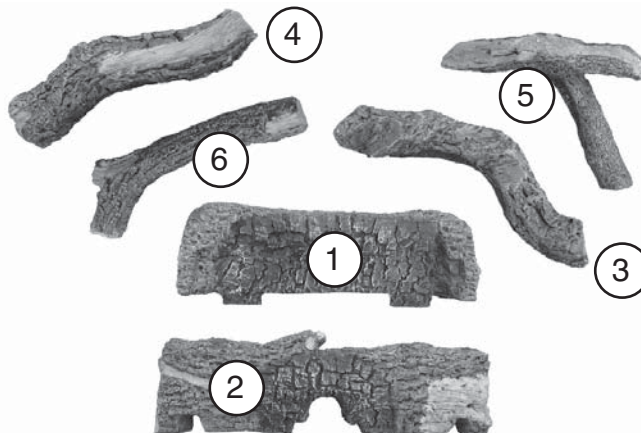

**MCO-24
Log Set Shown**

LOGS PARTS LIST (cont.)

Note: The log set is purchased and packaged separately.

MC(O,S)-(33,39) Log Sets					
Item	Description	Mountain Crest Oak (MCO)		Mountain Crest Split (MCS)	
		Part No.	Qty.	Part No.	Qty.
1.	Rear log	MCOL-28BR	1	MCOL-28BR	1
2.	33" Front log	MCOL-33BF	1	MCSL-33BF	1
or	39" Front log	MCOL-39BF	1	MCSL-39BF	1
3.	Left middle log	MCOL-10T	1	MCSL-10T	1
4.	Center middle log	MCOL-15TY	1	MCSL-15TY	1
5.	Right middle log	MCOL-10TR	1	MCSL-10TR	1
6.	Left top log	MCOL-13T	1	MCSL-13T	1
7.	Center top log	MCOL-11TL	1	MCSL-11TL	1
8.	Right top log	MCOL-15T	1	MCSL-15T	1

**MCO-33
Log Set Shown**

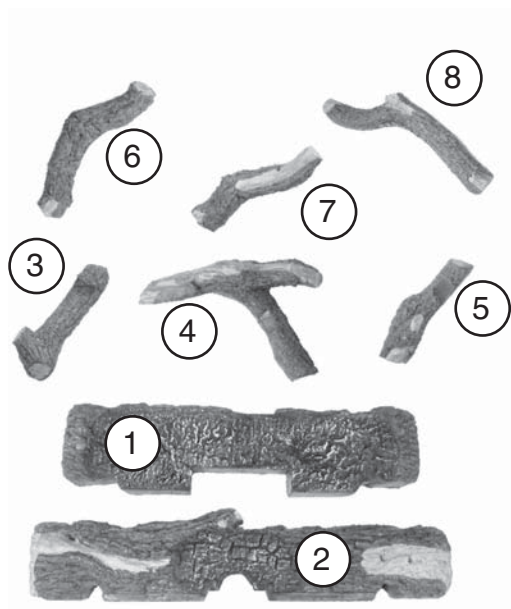

INSTALLATION

The Real Fyre burner system must be installed by a qualified professional service technician. Instructions must be followed carefully to ensure proper performance and full benefit from the burner system. **Check to be sure the burner system is designed and labeled for the type of gas (natural gas only) supplied to the fireplace.** Fireplace floor must be level, clean, and smooth (see FIREPLACE SAFETY INFORMATION section).

WARNING: Failure to position the parts in accordance with these diagrams or failure to use only parts specifically approved with this appliance may result in property damage or personal injury.

REFER TO THE BURNER PARTS LIST WHEN FOLLOWING THESE INSTRUCTIONS.

24" burner model shown here.

BURNER INSTALLATION

1. MAKE SURE THE FIREPLACE GAS SUPPLY IS TURNED OFF.
2. Locate the gas-supply stub inside the fireplace and remove the cap, if attached (reference Fig. 10-2).

CAUTION: When removing the cap, make sure the stub does not turn, loosening the connection inside the wall.

3. Remove the small adapter connected to the flex connector (included). Attach the adapter to the nipple found on the bottom of the burner pan using a pipe compound resistant to all gasses. Tighten securely. Then attach the flex connector to the adapter. Tighten securely (See Fig. 10-1).

4. Place the burner system in the fireplace. Center the burner from left to right in the fireplace. (Reference Fig. 10-2 for orientation.)

Note: Ensure the porcelainized panel is clean of all dust. Use a clean soft cloth if necessary. See Fig. 10-4.

5. **Be sure gas to the fireplace is off.** Remove the large adapter connected to the flex connector. Attach the adapter to the gas-supply stub using a pipe compound resistant to all gasses. Tighten securely. Then attach the flex connector to the adapter. Tighten securely (See Fig. 10-2).

6. **LEAKTEST:** Use a long-necked butane lighter, or lay a lighted match next to the burner pipe, and carefully turn on the gas supply until the burner ignites. Test at all connections for leaks using the appropriate soapy water solution. If bubbles appear, a leak is present. Turn off the gas and tighten at all connections. Repeat until no leaks are present. If a leak persists, turn off the gas supply and contact the local gas company or dealer. **NEVER USE A FLAME TO CHECK FOR LEAKS.**

Turn off the gas supply prior to proceeding.

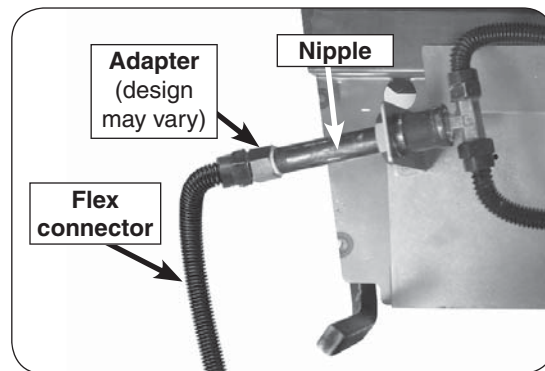

Fig. 10-1 Connect flex to burner

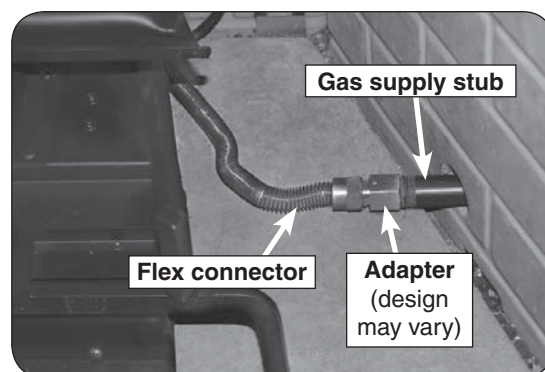

Fig. 10-2 Connect flex to gas supply

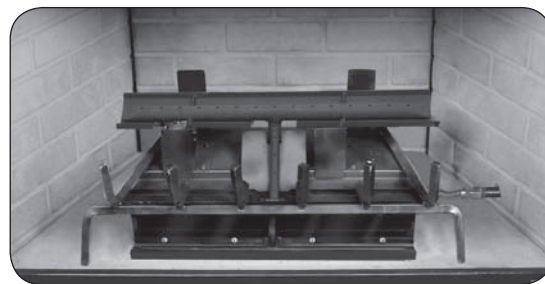

Fig. 10-3 Orientation

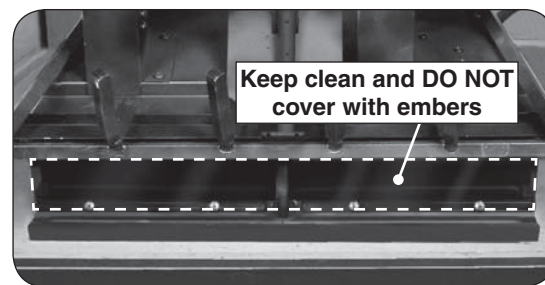

Fig. 10-4 Ensure a clean panel

LAVA GRANULES/COALS (DECORATIVE)

1. Spread the supplied lava granules on the floor of the fireplace, around the front and sides of the burner system (see Fig. 11-1).
2. Repeat this process for the supplied lava coals (on top of the already placed lava granules).

Note: DO NOT place any lava media on the burner system, or behind it.

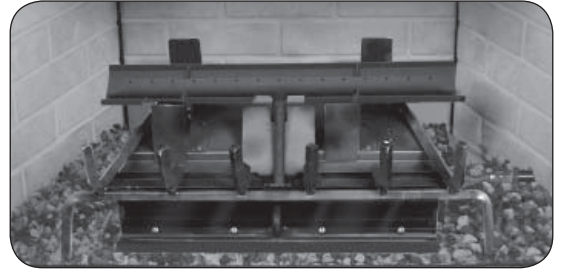

Fig. 11-1 Place lava media

INSTALLATION (cont.)

LOG SET AND EMBERS PLACEMENT [MC(O,S) log sets]

Log placement shown here is for MC(O,S) log sets. If a different log set has been purchased, follow the supplied supplemental instructions.

You must position and maintain the log layout as shown here to ensure optimal operation of the burner system. 24" log set shown below for generic placement steps. Final steps are separated by log set sizes. **Do not add any additional embers to this log set. Any additional embers may cause unsafe operation.** MCO log sets shown. Design may vary slightly; placement is the same.

CAUTION: BURN HAZARD! Logs will remain hot for some time after use. If you need to reposition any log to maintain the proper layout, use heat-resistant gloves or allow logs adequate time to cool before handling.

Generic Placement Steps

Important: DO NOT place any embers on top of the flash tube to ensure proper operation.

All models begin with the log and ember placement shown below. Continue with the appropriate section (on one of the following pages) specific to your log set size.

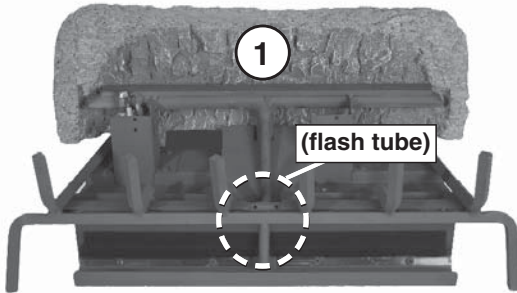

Place the rear log (log #1) as shown. The log should rest flat between the rear brackets and top burner.

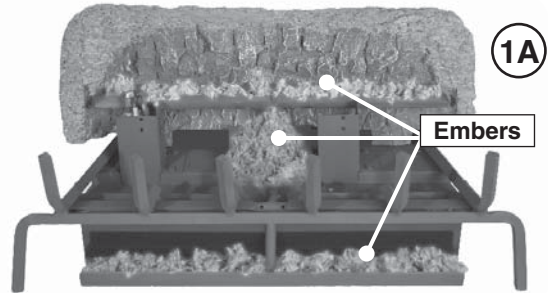

Place the supplied glowing embers evenly in the areas shown. **Break up any clumps that may have developed during shipment. Keep some embers for future placement along the front log.**

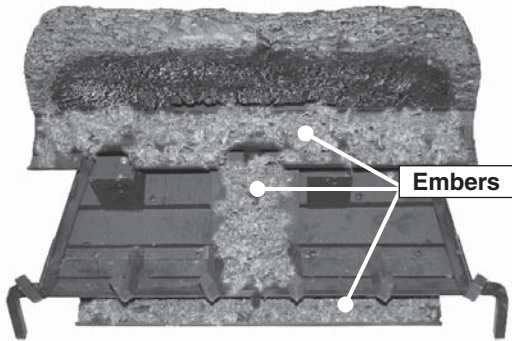

Ember placement detail.

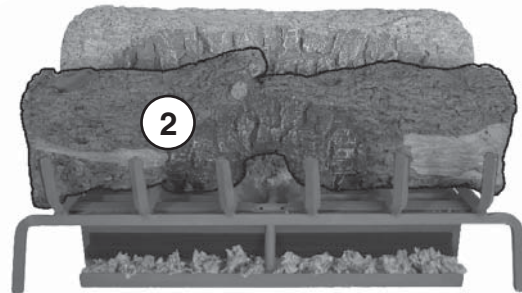

Place the front log (log #2) as shown. Rest the log with its back against the burner assembly behind it. **DO NOT** place it forward or on top of the grate fingers.

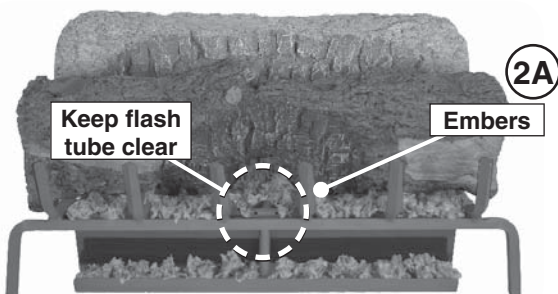

Place the remaining glowing embers evenly in the area along the front log as shown.

Store any excess embers if applicable.

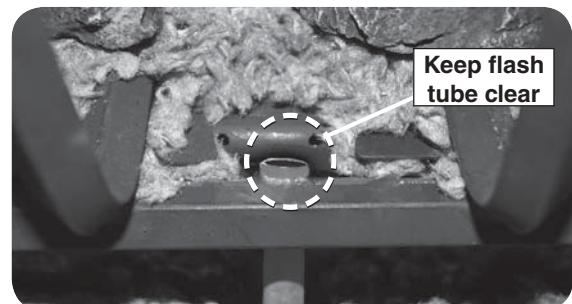

DO NOT place any embers on top of the flash tube to ensure proper operation. **Keep the area shown above clear at all times.**

Generic Placement Steps (cont.)

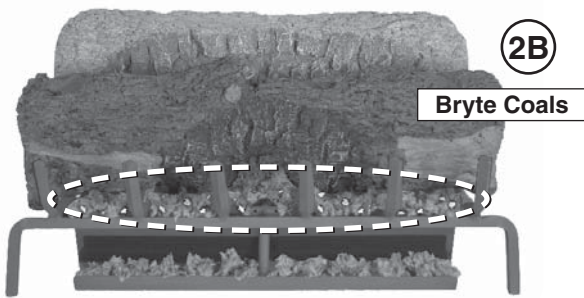

Separate half of the supplied bryte coals into small pieces, and evenly place them over the glowing embers in the middle ember bed as shown.

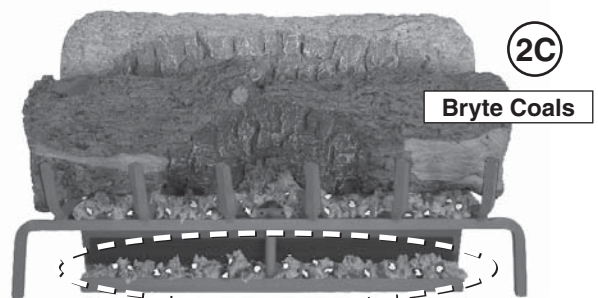

Separate the remaining (second half) of bryte coals into small pieces, and evenly place them over the glowing embers in the bottom ember bed as shown.

To complete log placement continue to the appropriate section specific to your log set size.

18", 24" & 30" Log Sets Only

For 18", 24", & 30" log sets, continue with the steps below to complete placement.

For 33" & 39" log sets, proceed to the following page.

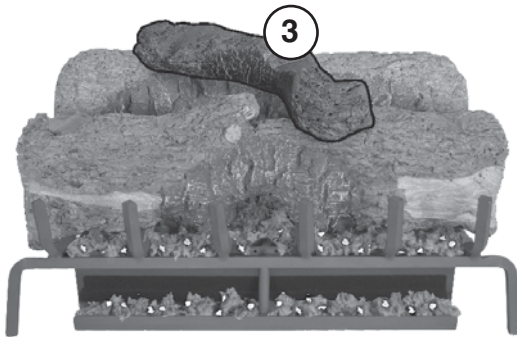

Place the center middle log (log #3) as shown. It will rest in the grooves found on the logs below.

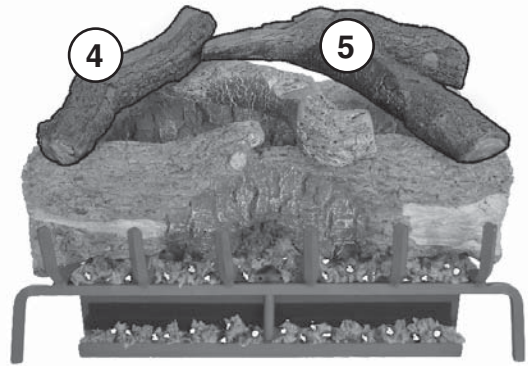

Place the left and right top logs (logs #4 & #5) as shown. They will rest in the grooves found on the logs below.

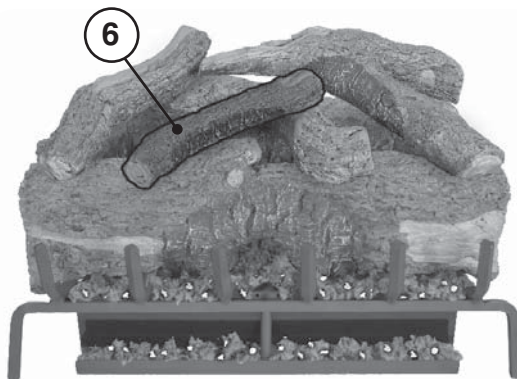

Place the center top log (log #6) as shown. It will rest on the front log and in the groove of the center log below.

INSTALLATION (cont.)

33" & 39" Log Sets Only

For 33" & 39" log sets, continue with the steps below to complete placement.

For 18", 24", & 30" log sets, go back to the previous page.

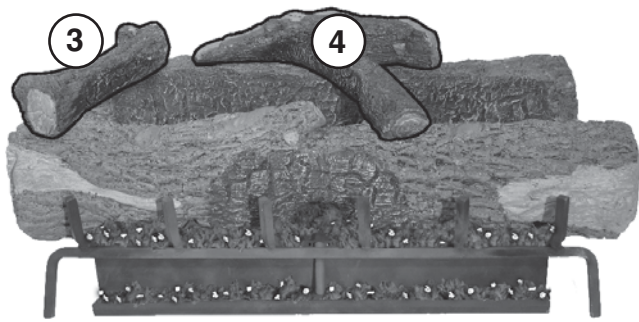

Place the left and center middle logs (logs #3 & #4) as shown. They will rest in the grooves found on the logs below.

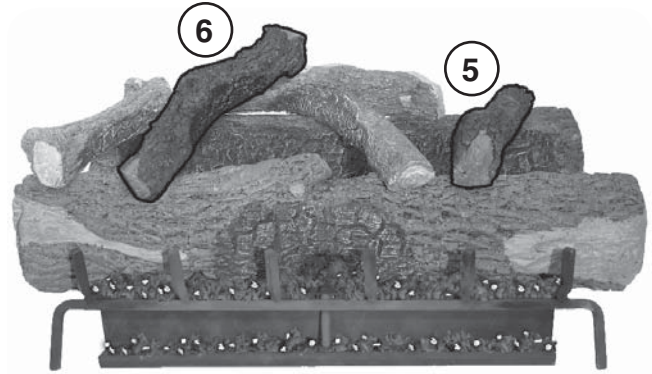

Place the right middle log (log #5) and the left top log (log #6) as shown. They will rest in the grooves found on the logs below.

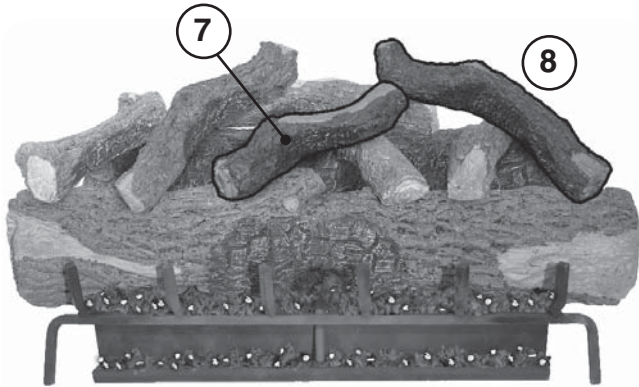

Place the center and right top logs (logs #7 & #8) as shown. They will rest in the grooves found on the logs below.

LIGHTING INSTRUCTIONS

FOR YOUR SAFETY, READ BEFORE LIGHTING

WARNING: IF YOU DO NOT FOLLOW THESE INSTRUCTIONS EXACTLY, A FIRE OR EXPLOSION MAY RESULT, CAUSING PROPERTY DAMAGE, PERSONAL INJURY, OR LOSS OF LIFE.

- A. BEFORE LIGHTING**, smell all around the unit area for gas. Be sure to smell next to the floor, because some gas is heavier than air and will settle on the floor.
- B. WHAT TO DO IF YOU SMELL GAS**
1. Shut off the gas to the appliance.
 2. Extinguish any open flame.
 3. If odor continues, immediately call your gas supplier or the fire department.
- C.** Use only a proper key to turn the gas line valve. Never use tools. If the valve will not turn, **DO NOT** try to repair it. Call a qualified professional service technician. Force or attempted repair may result in fire or explosion.

1. **STOP!** Read the safety information above.
2. Ensure the key valve is completely in the **OFF** position before beginning lighting sequence.
3. Lay a lighted long-stem match on the center of the top burner (**do not hold the match in your hand**) or use a lighted long-necked butane lighter (Fig. 15-1).
4. **Once the match is burning and in position**, slowly turn the key valve counter-clockwise toward the **ON** position until it no longer rotates (see Fig. 15-2). Your burner should light.

WARNING: If the burner does not light within (5) seconds of turning on the key valve, immediately turn the key valve clockwise toward the **OFF** position until it no longer rotates.

Wait approximately five (5) minutes to clear out any gas, and repeat steps 3-4 above.

If your burner fails to light again, turn the key valve clockwise toward the OFF position until it no longer rotates and contact your dealer or gas supplier.

Note: The flame height can be adjusted via the key valve.

TO SHUT OFF GAS TO THE APPLIANCE

To extinguish your gas burner, turn the key valve clockwise toward the **OFF** position until it no longer rotates (see Fig. 15-2). Be sure the key valve is turned fully off to avoid any gas leakage.

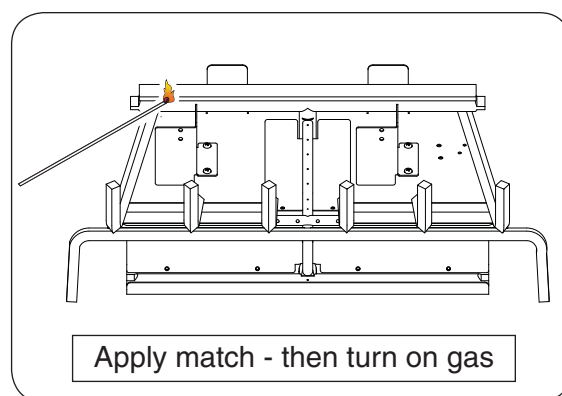

Fig. 15-1

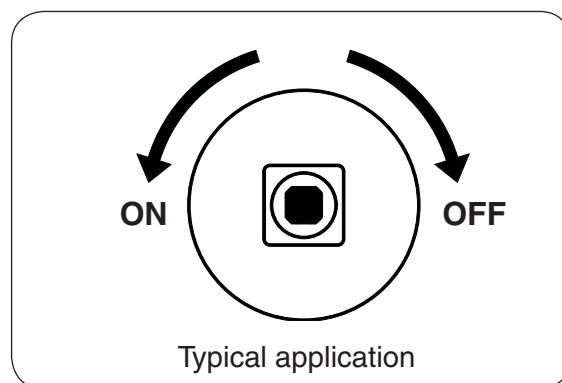

Fig. 15-2

CLEANING AND SERVICING

Note: Servicing may be necessary to ensure proper operation and burn characteristics.

Always shut off the gas to the appliance while performing service work.

Allow the appliance to cool before servicing.

Installation, service, and repair must be done by an NFI Certified or other qualified professional service technician. The appliance should be examined before use, and must be inspected at least annually to prevent burner shutdown, sooting, odors, etc. It must be checked for clean burning operation with the correct tools to service this unit. More frequent servicing may be required. It is imperative that all components and compartments, burner(s), and circulating air passageways of the appliance be kept clean and free of all obstructions (as applicable).

In addition, a periodic examination and cleaning of the solid-fuel-burning fireplace venting system should be conducted by a qualified professional service technician.

Any safety screen or guard removed for servicing must be replaced prior to operating this appliance.

Verify proper operation after servicing.

If, after a period of use, the flames start to exhibit unusual shapes and behavior, or the burners fail to ignite smoothly, the burner may require cleaning or servicing. If this happens, it is recommended to contact the nearest dealer to get the appliance serviced.

Do not remove the rating plates or the warning tags. These are an integral safety and identification component of this appliance.

We recommend following these instructions at the beginning of each fireplace season and as needed throughout the year, depending on your usage pattern and the environmental conditions in your home.

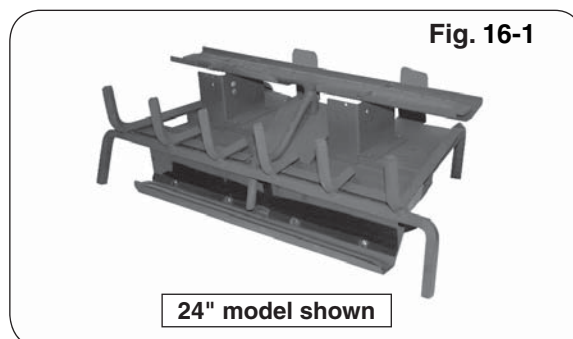

FLAME DESCRIPTION

Observe the flames. The top and middle burner flames should be blue at the base and a combination of blue/yellow at the body and at the tips. The top flames should be approximately 3-5" above the logs, with the center flame being the tallest. The middle flames should be approximately at or below the top of the front log. The ember flames should be 1/4" to 1" above the embers. (See 16-2 for example.)



Fig. 16-2 Flame appearance

TROUBLESHOOTING

POSSIBLE CAUSE	SOLUTIONS
1 BURNER SHUTTING DOWN DURING OPERATION	
A. Insufficient or excessive gas pressure	A1. Check gas pressure (Read D.- F. of IMPORTANT PRE-INSTALLATION AND FIREPLACE SAFETY INFORMATION section, & check with local gas company). A2. Other gas appliances may be on the same gas line, dropping gas pressure to burner system. Check pressures with everything operating to ensure adequate pressure.
B. Log placement	B. Reference the LOG PLACEMENT section in this manual for recommended log positioning.
C. Flue area, fireplace, or damper dirty from soot	C. Clean around, above, and under damper thoroughly. Clean fireplace, removing loose material, including soot and creosote.
D. Fireplace too small for unit	D. Ensure minimum requirements are met. (See SPECIFICATIONS section in this owner's manual.)
E. Blockages on burner	E. Vacuum any lava granules or material that may have fallen onto burner pipe area.
2 LOW FLAME HEIGHT	
A. Gas pressure	A. Check gas pressure (see Section 1, A1 of this table).
3 BURNER NOT BURNING EVENLY	
A. Burner orifice clogged	A. Clean burner orifice.
B. Top burner lights; bottom burner has delayed ignition.	B1. Check gas pressure. Can be caused by too small of a gas line (see Section 1, A1 of this table).
4 ODORS	
A. Gas leak	A. Shut off gas, if possible. Follow instructions on front page. Have a qualified professional service technician or the gas company correct all leaks.
B. New home, new carpet, or new paint	B. When these odors are drawn into the fireplace, this may cause objectionable odors. Thoroughly ventilate the area before restarting your burner system.
5 SOOTING	
A. On logs, in firebox, or room	A. Check gas pressure (see Section 1, A1 of this table).
B. Drafts in room	B. Eliminate drafts by closing heating and air conditioning vents, returns, and outside air vents. Fans blowing directly into fireplace should be turned off when set is operating.
C. Air shutters blocked (if applicable)	C. Air shutters are blocked with debris. Vacuum debris away from air shutter.
D. Log placement	D. See solution in troubleshooting 1B.
E. Using natural-gas burner on propane gas	E. If the gas listed on the nameplate does not match the gas you are burning, shut down the burner system immediately. Then call your dealer.
F. Adding any accessories to log sets	F. Shut down log set and take off any logs or accessories that do not belong with the set.

WARRANTY

PETERSON VENTED DECORATIVE GAS APPLIANCE LIMITED WARRANTY

Robert H. Peterson Co. ("RHP") warrants your Real Fyre® vented decorative gas appliance to be free from defects in material and workmanship.

Peterson vented ceramic refractory gas logs are warranted for **as long as you own them (lifetime)**.

Peterson vented burner assemblies are **WARRANTED for TEN (10) YEARS**. Peterson vented outdoor stainless-steel burner assemblies are warranted for **FIVE (5) YEARS**.

Peterson glass, gems, nuggets, and fiber-ceramic blend gas logs are warranted for **FIVE (5) YEARS**.

SPK-26 controls are warranted for **THREE (3) YEARS**.

APK-17 controls (including -17 valve) are warranted for **TWO (2) YEARS**.

All other Peterson valves, pilots, and controls are warranted for **ONE (1) YEAR (excluding batteries)**.

A COPY OF YOUR SALES SLIP FOR PROOF OF PURCHASE IS REQUIRED

This warranty applies to the original purchaser for products which are installed in the United States or Canada and which are operated and maintained as intended for single family residential usage. This warranty is valid only with proof of purchase, shall commence on the date of purchase, and shall terminate (both as to original and any replacement products) on the anniversary date of the original purchase of the product stated on the above schedules.

This warranty covers defects in material and workmanship. This warranty **does not** cover parts which become defective as a result of negligence, misuse, use not in compliance with the Owner's Manual/Installation Instructions, accidental damage, improper handling, improper storage, improper installation, **lack of required routine maintenance** (as specified in the Owner's Manual/Installation Instructions), electrical damage, local gas impurities or failure to protect against combustibles. Product must be installed (and gas must be connected) as specified in the Owner's Manual/Installation Instructions by a **qualified professional installer**. Modifications to products which are not specifically authorized will void this warranty. Accessories, parts, valves, remotes, etc. when used must be Peterson products or this warranty is void. Warranted items will be repaired or replaced at Peterson's sole discretion. This warranty **does not** apply to rust, corrosion, oxidation, or discoloration unless the affected part becomes inoperable.

This warranty **does not** cover labor or labor related charges, except as provided by separate specific written programs from the Peterson Co. All repair work must be performed by a qualified professional service person and requires prior approval of Peterson.

Peterson may require the defective product or part to be returned to the factory to determine the cause of failure. Peterson will pay freight charges if the product or part is determined to be defective. This warranty does not cover breakage in shipment from our (Independent) distributor to its customer if the damage is determined to have occurred during that shipment.

This warranty specifically excludes liability for **indirect, incidental, or consequential** damages. Some states and provinces do not allow the exclusion or limitation of incidental or consequential damages, so the above exclusion may not apply to you. This warranty gives you specified legal rights, and you may have other rights that vary from state to state or province.

For additional information regarding this warranty, or to place a warranty claim, contact the R. H. Peterson dealer where the product was purchased.

**TO REGISTER YOUR PRODUCT ONLINE GO TO: WWW.RHPETERSON.COM,
AND CLICK ON PRODUCT REGISTRATION. THANK YOU FOR YOUR PURCHASE.**

FOR USE IN THE COMMONWEALTH OF MASSACHUSETTS

**INSTALLATION OF THIS APPLIANCE MUST BE IN COMPLIANCE WITH 248 CMR: BOARD
OF STATE EXAMINERS OF PLUMBERS AND GAS FITTERS AND PERFORMED BY A
MASSACHUSETTS LICENSED PLUMBER OR GAS FITTER ONLY.**

**CONNECTOR KITS USED FOR INSTALLATION AND OPERATION OF THIS APPLIANCE
MUST NOT BE MORE THAN 36" IN LENGTH.**

**FIREPLACE DAMPER MUST BE REMOVED OR PERMANENTLY FIXED/WELDED IN FULL
OPEN POSITION PRIOR TO INSTALLING THIS PRODUCT.**

Quality Check

Date: _____

Burner Orifices	Nat. _____	Leak Test:	_____	Model#:	_____
Main:	_____	Burn Test:	_____	Serial#:	_____
Other:	_____	Gas Type:	Nat. _____	Air Shutter:	_____
				Inspector:	_____