

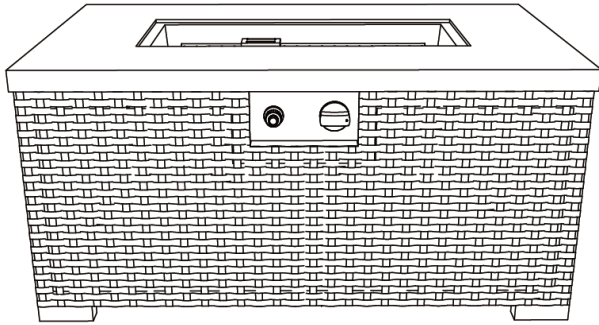

WAR-840 Gas Fire Table



! DANGER

If you smell gas:

1. Shut off gas to the appliance.
2. Extinguish any open flame.
3. If odor continues, keep away from the appliance and immediately call your gas supplier or fire department.

! WARNING

Do not store or use gasoline or other flammable vapors and liquids in the vicinity of this or any other appliance. An LP-cylinder not connected for use shall not be stored in the vicinity of this or any other appliance.

! WARNING

For outdoor use only.

! WARNING

Improper installation, adjustment, alteration, service or maintenance can cause injury or property damage. Read the owner's manual thoroughly before installing or servicing this equipment. If the information in this manual is not followed exactly, a fire or explosion may result causing property damage, personal injury or loss of life.

Save these instructions for future use. If you are assembling this unit for someone else, give this manual to him or her and read and save for the future.

Purchase Date: / / Order/Customer Ref. Number:

Thank you for choosing Sunnydaze Decor. We stand behind our brand and the quality of the items we sell. Replacement parts or products will be sent at our discretion within the 1-year warranty period. Proof of purchase, with the date of purchase as well as photos of the merchandise defect, must be provided. Photos are used to determine the cause of defects and for future quality control. Register your warranty at www.serenityhealth.com/warranty/

If you have any questions, comments or concerns, feel free to contact us by phone at 888-881-4668, by email: customerservice@serenityhealth.com, or via our contact us page at www.SerenityHealth.com/contact-us/

LIMITATION OF WARRANTY AND LIABILITY

NOTICE: Read this Limitation of Warranty and Liability Before Using This Product. If the Terms Are Not Acceptable, Return the Product at Once, Unopened, and the Purchase Price Will Be Refunded.







It is impossible to eliminate all risks associated with the use of this product. Such risks arise from weather conditions, the manner of use or application, or other unknown factors, all of which are beyond the control of the Seller and Manufacturer. These risks can cause bodily injury or death, ineffectiveness of the product, and damage to other property. Seller and Manufacturer do not agree to be an insurer of these risks you agree to accept these risks.

Seller and Manufacturer warrant that this product is reasonably fit for the purpose stated in the Owner's Instructions Manual, subject to the inherent risks described above, when used in accordance with the Owner's Instructions Manual under normal conditions. Seller and Manufacturer provide no other express or implied warranty of fitness or of merchantability or any other express or implied warranty

In no event shall Seller or Manufacturer be liable for any incidental, consequential, or special damages resulting from the use or handling of this product. Buyer's or user's bargained-for expectation is for home use of the product in accordance with the Owner's Instructions Manual and under normal conditions and that is the exclusive remedy of the user or buyer and the exclusive liability of Manufacturer or Seller, for any and all claims, losses, injuries or damages (including claims based on breach of warranty or contract, negligence, tort or strict liability) resulting from the use or handling of this product, shall be the return of the purchase price of the product or, at the election of Manufacturer or Seller, the replacement of the product

Any claim by buyer or user of this product shall be filed within one (1) year of the date of injury or damage or the claim will be barred. Buyer and user waive any right to file any class action claim for product defect, design defect, or failure to adequately warn of product hazards or safe installation.

This Limitation of Warranty and Liability may not be amended by any oral or written agreement.

 WARNING	FOR OUTDOOR USE ONLY !
 DANGER	If you smell gas and/or hear a gas hissing sound: 1. Immediately, SHUT OFF gas to the appliance. 2. Extinguish ALL open flames. 3. If odor continues, keep away from the appliance and immediately call your Gas Supplier or Fire Department.
 DANGER	DO NOT store or use gasoline or other flammable vapors and liquids in the vicinity of this unit and or any other appliance. An LP Gas tank not connected for use shall not be stored in the vicinity of this or any other appliance.
 DANGER	Improper installation, adjustment, alteration, service or maintenance can cause injury or damage to property. Read and understand the Owner's Manual thoroughly before installing or servicing this Fire Table / Column. If the information in this Owner's Manual is NOT followed exactly, a fire or explosion may result and cause property damage, personal injury or loss of life.
 DANGER	CARBON MONOXIDE HAZARD. This appliance can produce carbon monoxide which is odorless.
	Using it in an enclosed space can kill you. Never use this appliance in an enclosed space such as inside a camper, tent, car or home.
<p align="center">Save this Owner's Manual and these instructions for future use. If you are assembling this unit for someone else, give this Owner's Manual to them to read.</p>	
<p align="center">  Intertek 5010198 </p>	

Part A.**SAFETY INFORMATION**

Before you assemble or operate this unit, please read carefully this entire Owner's Manual. Failure to do so may result in a fire, explosion, injury or death.



The installation of this unit must adhere to local codes or either the National Fuel Gas Code, ANSI Z223. 1/NFPA54, OR CAN/CGA-B149.1, National Gas and Propane Installation Code.

• THIS UNIT IS INTENDED FOR OUTDOOR USE ONLY!

This product shall be used outdoors, in a ventilated space and shall not be used in any enclosed area.

• This unit is to be used with LP Gas / Propane Gas only !
(Propane Gas tank is not attached and not delivered with this unit.
Propane and Gas Tank is sold separately).

• Do not attach a remote gas supply to this unit.

• This unit is NOT intended for Natural Gas.

• Converting this unit to Natural Gas is dangerous and not recommended.
The conversion of this unit shall void the manufacturer warranty.

• Do not use any solid fuel or charcoal for this unit.

• When igniting this unit, exercise caution as some gas pooling from the Burner may cause the flame to flare that could cause injury.

• LP GAS WARNING : Do not use more than 1/4 inch depth of lava rocks / pumice stones above the burner holes.
Excessive use of lava rocks / pumice stones, will suffocate the flame.

• If the Propane Gas Tank is leaking gas, you can smell, hear a hiss, or sense a leak at the source.
Do the following:
1. Disconnect the Propane Gas tank.
2. DO NOT attempt to fix the problem yourself.
3. Move yourself and all persons away from the immediate area.
4. Only when everyone is at a safe distance away from the Fire Table / Column, contact your Gas Supplier or Fire Department for help.

• Applying too much Propane Gas may result in gas pooling and will NOT burn.
Allow fresh air into the unit so that the remaining gas may escape.

• DO NOT use a flame to check for gas leaks.

• The maximum inlet supply pressure: maximum Gas supply 11 inch w.c. (2.74kPa)

• Use LP propane tanks with the following dimensions: diameter 12 in, height 18 in - capacity 20lbs.

• You must use a Propane Gas Tank that has a collar₄ to protect the Gas Valve.

- **DO NOT** fill tank over 80% full.
- The tank system must be set up for vapor withdrawal.
- **STOP** using if any part of the Propane Gas Tank is damaged.
Rust and dents in tank may be hazardous and should be inspected by a Gas Supplier.
- **DO NOT** burn anything other than the provided materials for this Fire Table.
- Keep away from the unit for the first 20 minutes after igniting your unit for the first time, as lava rocks / pumice stones could pop out and cause injury.
Should any rocks pop out, discard them.
- Always ensure that lava rocks / pumice stones are completely dry before use.
Failure to do so will cause them to crack or pop.
- **DO NOT** operate unit until all parts are fully assembled.
- **DO NOT** paint or color any part of this Fire Table / Column.
- Unit may be hot while in use, **DO NOT** attempt to move it while in use.
- Never leave this Fire Table / Column unattended while in use.
- This unit is **NOT** intended for cooking.
- Keep all flammable items away and **DO NOT** use any other fireplace cover for this unit.
- Keep a safe distance to avoid burning skin or clothing.
- **DO NOT** sit or rest hands or feet on this Fire Table / Column.
- Never place hands or fingers onto upper portion of this unit while in use.
- Keep all electrical cords and fuel supply hose away from heated surfaces.
- Combustible material should **NOT** be within 72 inches of the top of the unit, and within 48 inches around the entire unit.

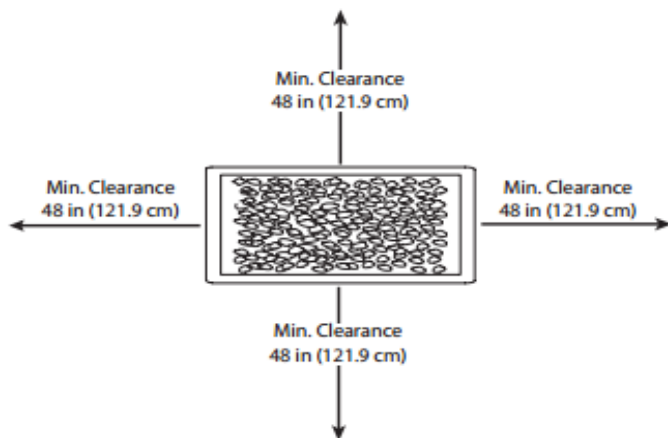

• **Keep the appliance area clear and free from combustible material, gasoline and other flammable vapors and liquids.**

• **If the flame goes out while burning, turn the gas valve off.
Wait 5 minutes before repeating the initial lighting procedure.
Once you have a flame started, hold down the control knob for 1 minute.**

• **DO NOT add water into the unit.**

• **DO NOT operate unit if any part has been under water.
Immediately call for a Qualified Service Technician to inspect the appliance.
Where necessary, secure Qualified Service Technician to replace part(s) of the Control System and any gas control parts that has been under water.**

• **DO NOT disconnect any part while the unit is in use.**

• **DO NOT store a spare Propane Gas Tank on or near this unit.**

• **If the Fire Table / Column is placed indoors for storage, detach the Propane Gas Tank and leave the tank outdoors.
This unit is for outdoors use ONLY.**

• **DO NOT operate on a boat or vehicle.
This unit can only be used on any stationary outdoor flat surface ONLY**

• **Always remove protective cover before operating (where applicable) and / or use of your Fire Table / Column.**

• **DO NOT set the Protective Cover (E) over the unit until the Fire Table / Column is turned off and completely cooled down (where applicable).**

• **Check for leaks after not using the unit for long periods of time.**

• **Children must never operate this Fire Table / Column.
Children must be supervised AT ALL TIMES while near this Fire Table / Column.**

• **The maximum gas supply pressure is 250psi.**

• **All installation and repair should be done by a Qualified Service Technician.
This unit should be inspected annually and cleaned regularly.**

• **Inspect all elements of this Fire Table / Column before each use.
If there is damage, the Burner must be replaced.**

• **Be aware of the hazards of high temperatures and stay away from the unit to avoid any burns or injury.**

• **The gas supply tank should be constructed and marked with the specifications for the LP Gas tanks of the U.S. Department of Transportation or the National Standard of Canada CAN/CSA-B339, LP Gas tanks, spheres and tubes for Transportation of Dangerous Goods and Commission.**

• **The LP Gas tank must have a listed overfilling prevention device and a QCCI or Type I, LP Gas tank connection.**

• **This heating appliance should NOT be used on plastic, artificial wood desks or any desk.**

• Children and adults should be alerted to the hazards of high surface temperatures and should stay away to avoid burns or clothing ignition.

• Young children MUST BE carefully supervised at all times when they are in the area of this appliance.

• Clothing or other flammable materials shall NOT be hung from the appliance or placed on or near the appliance.

• Any guard or other protective device removed for servicing the appliance shall be replaced prior to operating and use of this appliance.

• Installation and repair(s) should be done by a Qualified Service Technician.

The appliance should be inspected before use. If you suspect there are issues, contact a Qualified Service person.

More frequent cleaning may be required as necessary.

It is imperative that the control compartment, burners and circulating airways of the appliance are kept clean.

When APPLICABLE:

• Keep gas tank at least 5 feet away from unit when lit (if external tank).

• Allow Fire Burner / Column to cool down completely before placing on lid.

• Keep the hose away from any pathways to eliminate any accidental damage (if external tank).

• DO NOT use Fire Table / Column while lid is installed.

Always remove the lid while Fire Table / Column is in use.

Use only the Regulator (12/19) and Hose(12) assembly provided with this unit.

Replacement parts must be supplied directly by manufacturer.

Inspect the Burner (08) before use of this unit.

If the Burner (08) shows any kind of damage, DO NOT operate the appliance.









NOTE: You must follow all steps to properly assemble this Fire Table / Column.

Make sure the Gas Valve is turned "OFF" before assembling.

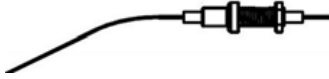
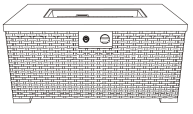
DO NOT attempt to assemble without proper tools.

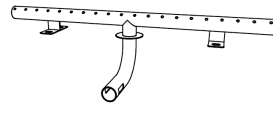

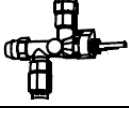

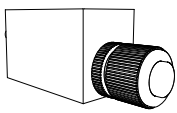
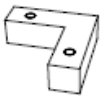

Parts Diagram

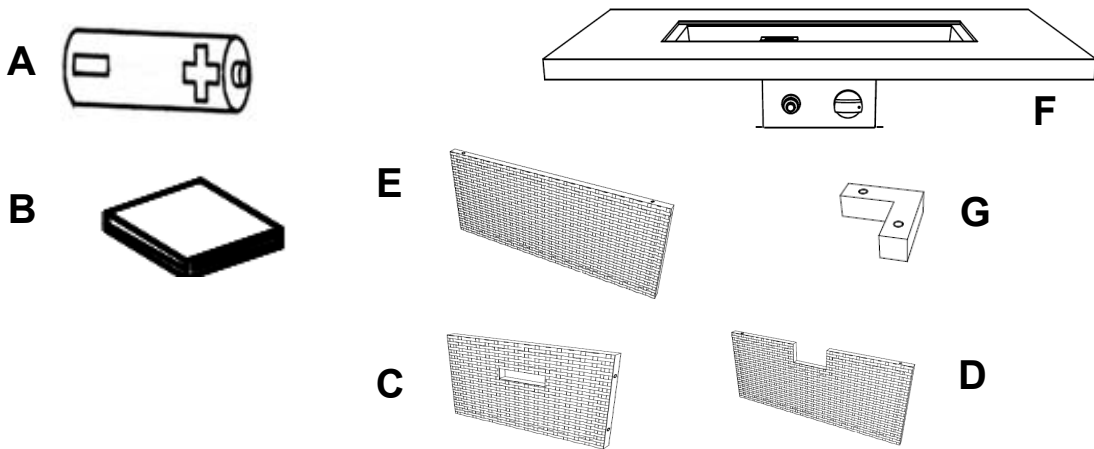
Tabulated here below are the description to all parts as shown in above Picture .

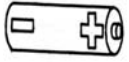

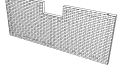
Item	Picture	Description	Qty
01		Guard	1
02		Thermocouple	1
03		Ignition Pin	1
04		Main Frame of Fire Table	1
05		Lava Rocks	1
06		Burner	1
07		Nozzle	1
08		Corrugated Pipe	1
09		Switching Valve	1
10		Regulator Valve with Gas Hose	1
11		Control Knob	1
12		Ignitor	1
13		Foot	4

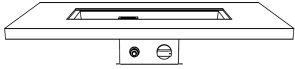
Parts List

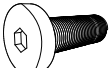
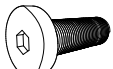

Item	Picture	Description	Qty
A		AA Battery	1
B		Protective Cover	1
C		Panel C	2
D		Panel D	1
E		Panel E	1
F		Table Top	1
G		Foot	4

Hardware

Item	Picture	Description	Qty
G\$\$%		Bolt (M6*35MM)	12
G\$\$&		Bolt (M6*40MM)	8
K \$\$%		M6 Washer	12
H\$\$%		Hex Bolt Driver	1

Assembly Instructions

Step 1:

Attach panel (D) and the panel (E) to the table top (F) by using 4pcs of Bolts (S001) and 4pcs M6 washer (W001) with Hex Bolt Driver (T001). Please do not fully tighten.

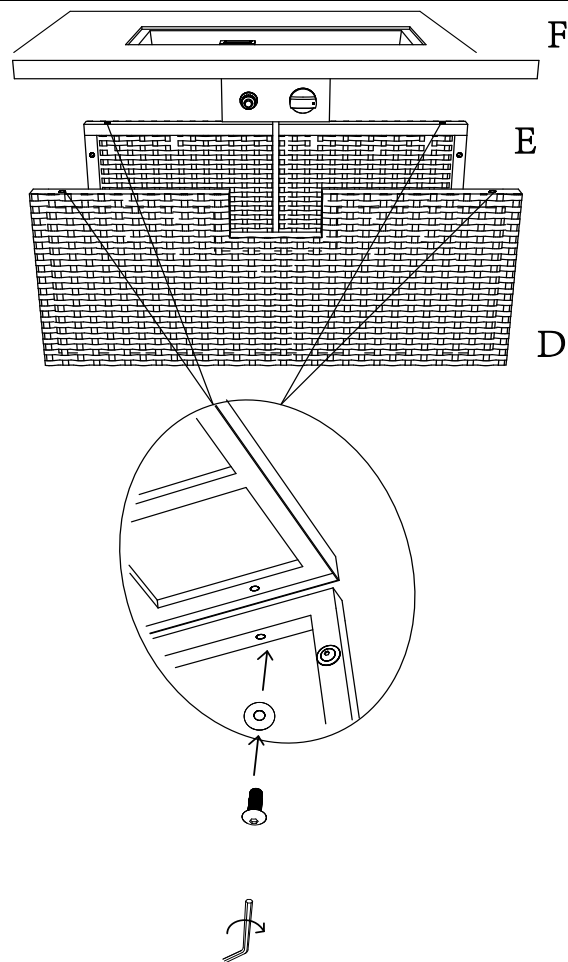

Step 2:

Attach panel (C) with Panel (D) and Panel (E) together by using 8pcs Bolts (S001) and 8pcs M6 washer (W001) with Hex Bolt Driver (T001). Please do not fully tighten.

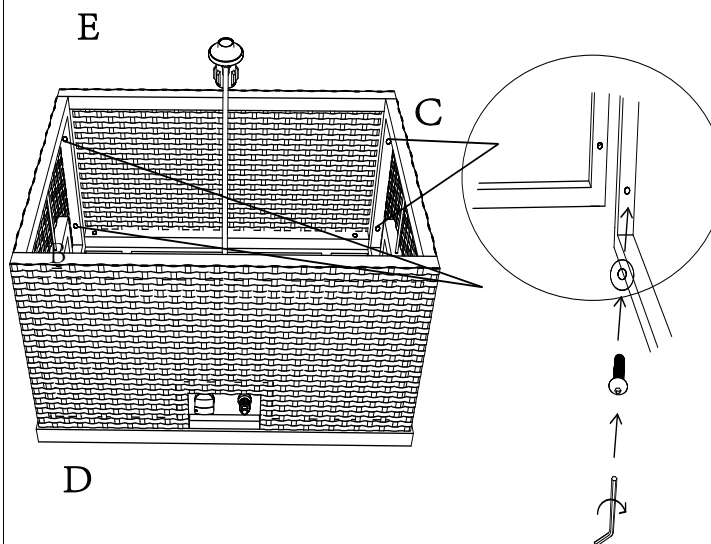

Assembly Instructions

Step 3:

Attach adjust foot (G) to the bottom of fire pit using 8pcs of Bolts (S002) with Hex Bolt Driver (T001). And tighten the Bolts.

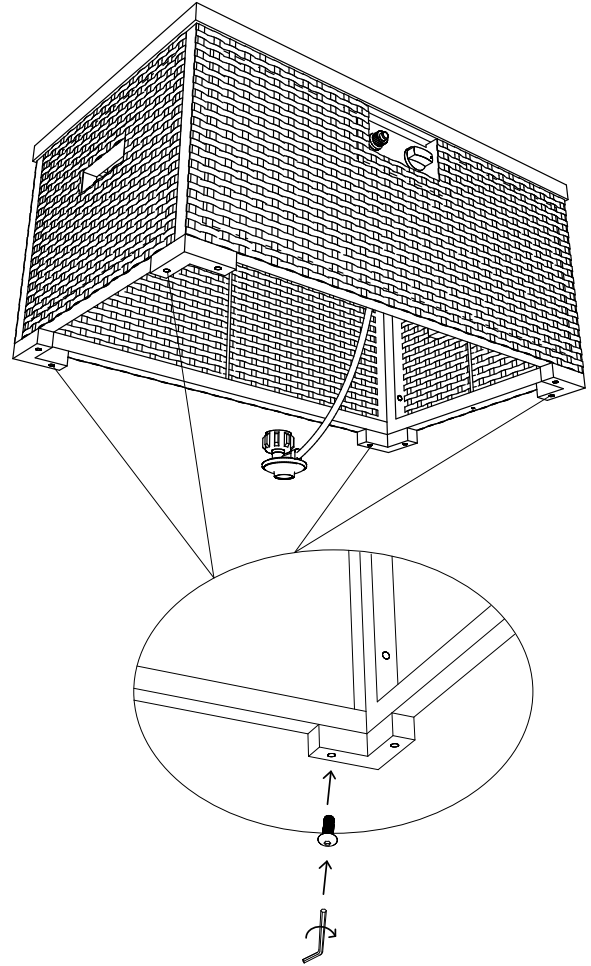

Step 4:

Then tighten all the bolts.

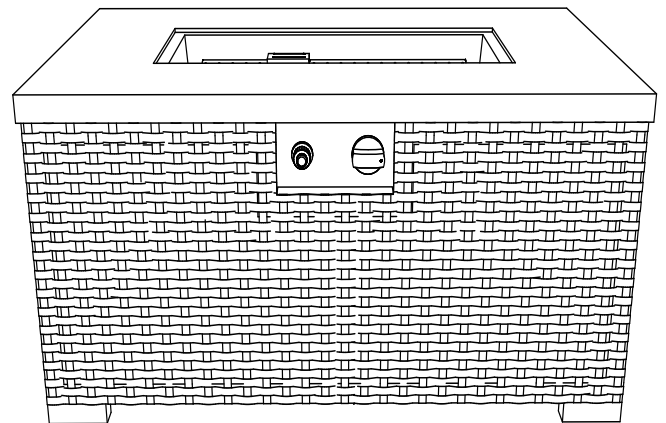

User's Instructions

Step 1:

1. Check that the Control Knob for the gas supply system is turned to the OFF position before starting any assembly.
2. Place a 20 lb Propane Gas Tank (not included) into a secure position.

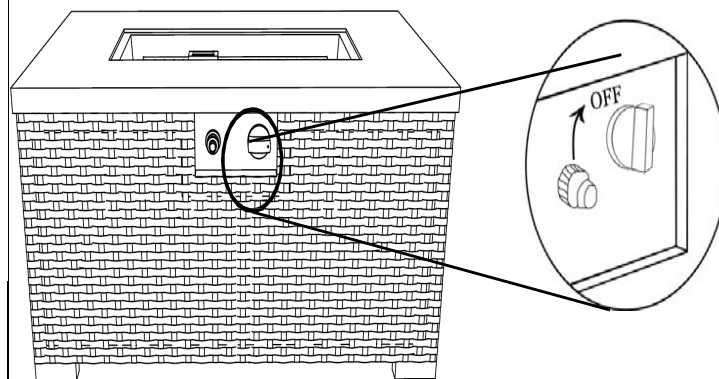

Step 2:

Turn the Cylinder Valve on the tank in a clockwise direction to TURN OFF SUPPLY of the LP Gas supply-Attach the preassembled Regulator (19) from the Fire Table to the Cylinder Valve (21) by turning the Black Regulator Coupling Nut clockwise.

Make sure it is fastened securely and tighten connections-by HAND only.

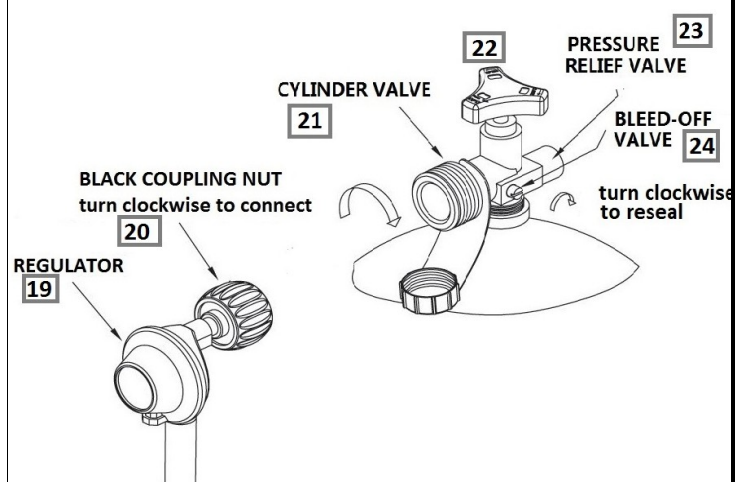

User's Instructions

Step 3:

Remove the Electronic Igniter Cap on the Electronic Igniter by unsecuring and slide the Battery (A) into the battery slot. Make sure the positive side of the Battery faces outwards. Screw the Electronic Igniter Cap over the battery, tightly.

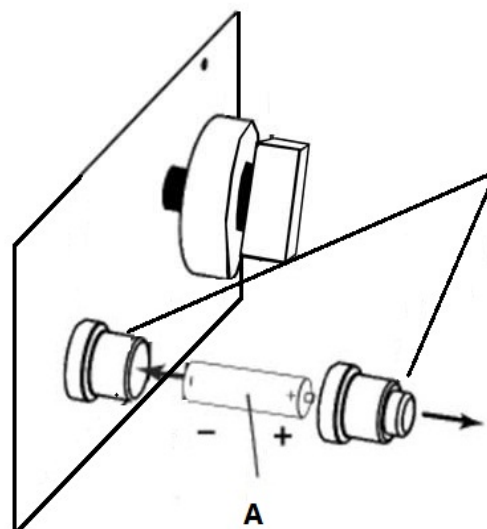

Step 4:

Put Lava Rocks over the Burner Ring.

Warning: DO NOT PLACE LAVA ROCKS ON THE GUARD. KEEP GUARD CLEAR.

To ensure proper function, the Guard (01) on the Burner (06) should never have lava rocks (05) covered over it.

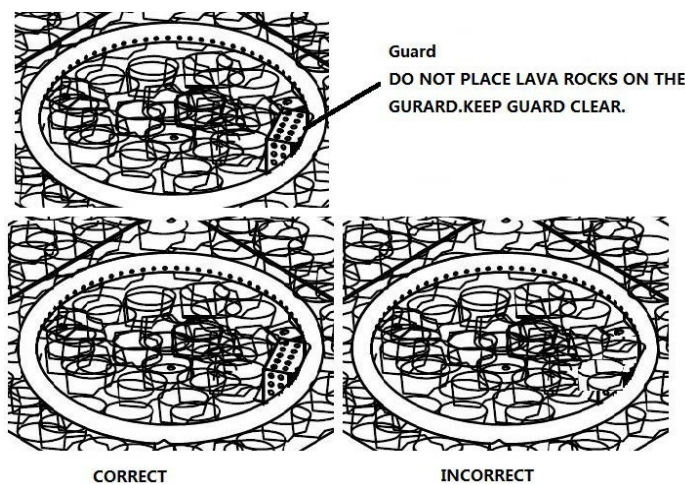
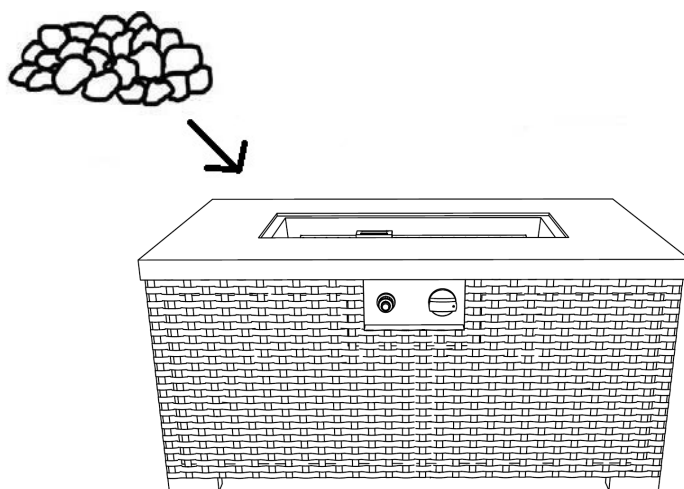

OPERATION

Before performing a leak test, be sure that no sparks can occur and you are in a spacious outdoor area. Connect the propane gas tank to the regulator and turn the valve on the unit to the “off” position. Brush a soap and water mixture on all connections. Turn the gas supply on; if bubbles occur on any connection there may be a leak. **If you smell gas or a leak is discovered turn the gas valve off, disconnect propane gas tank and do not use the appliance until the leak is repaired.**

Do not use the heating unit without inspecting the gas hose. If there are signs of wear or abrasion you must replace the hose (if applicable). Lava rocks could pop up and strike somebody’s face during the process of lighting this unit; stand away from the unit for the first 20 minutes after igniting. Flame height should be a yellow/blue color between 2 - 10 inches in height.

Wait 5 minutes after extinguishing flame prior to placing a lid (if applicable) or protective cover on heating item.

To Light

1. Make sure the control knob (I) is in the “off” position.
2. Remove door (C) and slowly open the valve on the propane gas tank by turning the knob counterclockwise.
3. Replace the door (C) on the body (B).
4. Push and hold in the electronic igniter (J) to create sparks within the electrode, continue to hold.
5. Push in the control knob (I) and turn to the “low” position. Keep holding down the control knob (I) to allow gas to flow for 45 seconds.
6. If ignition doesn’t occur within a few seconds release the control knob (I) and rotate to the “OFF” position. Wait for 5 minutes for gas to clear and then repeat the above lighting instructions.
7. Once the fire product is lit, the flame intensity may be controlled by turning the control knob (I) between the “low” and “high” positions.

To Extinguish

1. Turn control knob (I) clockwise to the “low” position; let the knob pop up and continue turning the control knob (I) to the “off” position.
2. Close the cylinder valve on the propane gas tank if you don’t intend to use it for a long time.

MAINTENANCE

- Before performing any maintenance always disconnect propane gas tank.
- Keep the heating item free and clear from combustible materials.
- Visually inspect burner for obstructions and keep tank enclosure free and clear from debris.
- Use a soft brush to get rid of the mild stains, loose dirt and soil after the burner and lava rocks are completely cooled down. Wipe down with a soft cloth.
- Harsh weather conditions may cause stubborn stains, discoloration and possibly rust pitting.
- Permanent damage may occur if powder or solvent comes in contact with painted or plastic components on this heating unit.
- Keep the heating unit stored away from direct sunlight.
- If storing this unit inside, disconnect the propane gas tank from the gas valve.
- Not using manufacturer approved or supplied parts/accessories may result in a defective condition and void the warranty of this heating unit.
- Always place lid (if applicable) or protective cover on heating item when not in use.

MGO Surface Care

Our MGO material has been sealed with a special treatment to prevent staining and moisture absorption, but it does require proper maintenance to ensure the integrity of the surface. Please see below for recommendations on maintaining your MGO surface for years of pleasure:

- Clean any spills immediately to prevent permanent MGO surface staining or damage.
Blot any liquid spills with a clean, dry cloth to avoid spreading of the spill to the rest of the table. Clean your product surface with a soft, clean cloth or sponge. Mix a solution of warm clean water and mild dish soap to remove any surface dirt or mild spills. Rinse all soap solution off of the tabletop and dry completely to avoid water spots. Regularly cleaning the surface will aid in a longer lasting product.
- Do not use petroleum-based or abrasive cleaning products. Do not use any harsh brushes when cleaning the surface.
- Do not slide products across the surface to avoid permanent scratching and damage.
- Always use protective mats such as coasters or placemats when eating on an MGO surface. These protective products will help absorb sweating on cool beverages and will block out any heat rings from appearing beneath a warm mug or plate. When placing hot dishes on MGO surface, always use mats or hot pads.
- MGO surface must be covered at all times when not in use. Cover your product with an outdoor furniture cover when not in use to protect it from the elements. **Store your product indoors during winter months. Avoiding extreme cold temperatures will prevent cracking of the tabletop.**

Troubleshooting

Problem: Burner will not light using igniter

Please review the Helpful Tips on page 15 for common fixes to this problem.

Possible Cause 1: Electrode and burners are wet.

-Wipe dry with cloth.

Possible Cause 2: Igniter battery is dead or backwards.

-Check that the AAA battery is inserted correctly in the igniter (see below photo) or replace the battery. Make sure the plastic wrap on the battery has been removed.

Possible Cause 3: Igniter Pin cracked or broken - sparks a crack.

-Please contact Net Health Shops,LLC to request the parts.

Possible Cause 4: Residue on Igniter Pin.

-Check for residue on the igniter pin or Thermocouple. If dirty,thoroughly clean the area.

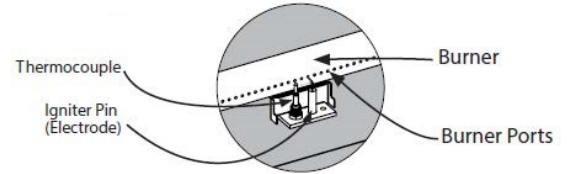

Problem: Burner will not light with match

Possible Cause 1: No Gas Flow

-Check if the LP gas tank is empty. If empty, replace and refill. If the propane tank is not empty, refer to **Problem: Sudden drop in gas flow** on the following page.

Possible Cause 2: Coupling nut and regulator not fully connected.

-Turn the coupling nut about one half to three fourths a turn, until you feel a solid stop. Do not use tools, tighten by hand only.

Possible Cause 3: Obstruction of gas flow.

- Check for bent or kinked hose.

Possible Cause 4: Spider webs or insect nest in the venturi.

- Clean the venturi.

Possible Cause 5: Burner ports clogged or blocked.

-Reference **Problem: Irregular flame pattern** on the following page. Clean the burner ports as described there.

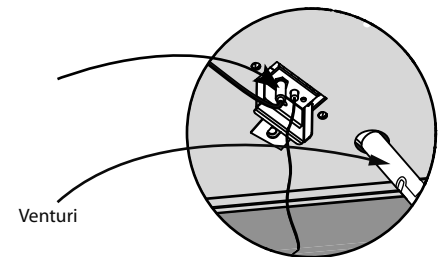

Problem: The fire table emits a lot of black smoke when in use

Possible Cause 1: Hose from gas fire table is pinched.

-Make sure the hose is not pinched between the fire table and the source of the gas.

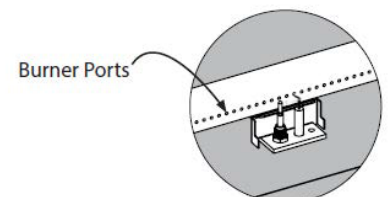

Possible Cause 2: Flame is being obstructed at burner ports.

-Make sure that the gas ports on the burner are free of any lava rocks/fire glass so that the flame can flow naturally.

-Clear out the mixing chamber located before the Venturi.

Possible Cause 3: Mixing chamber of the burn tube is blocked or obstructed.

Problem: Sudden drop in gas flow, or a reduced flame height

Possible Cause 1: Out of Gas.

-Check for gas in the LP gas tank.

Possible Cause 2: Excess flow safety device may have been activated.

-Turn control knob to **OFF**, wait 30 seconds and light outdoor fire table. if flames are still too low, reset the excessive flow safety device by turning off the control knob and LP gas tank valve. Disconnect regulator. Turn burner control knob to **HIGH**. Wait at least 5 minutes. Turn burner control knob off. Reconnect regulator and perform a leak check at tank connection. Turn LP gas tank valve on slowly, wait 30 seconds and then light outdoor fire table.

Problem: Irregular flame pattern, flame does not run the full length of the burner

Possible Cause: Burner ports are clogged or blocked.

-Clean burner ports. Do this by inserting a paperclip into each of the burner ports to ensure they are not clogged.

WARNING: Make sure burner is not on, and has had sufficient time to cool before touching it.

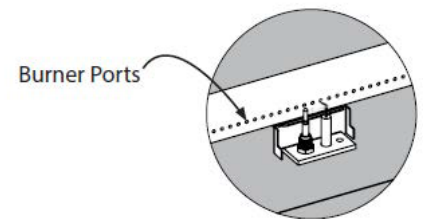

Problem: Flame blow out

Possible Cause 1: High or gusting winds.

-Increase flame to **HIGH** setting.

Possible Cause 2: Low on LP gas.

-Replace or refill LP gas tank.

Possible Cause 3: Excess flow valve tripped.

-Refer to **Problem: Sudden drop in gas flow**

Problem: Flame seems to lose heat when burning in cold weather - temperature below 50°F

Possible Cause 1: Ice has built up on the outside of the LP gas tank because the vaporization process is too low.

-Turn the control knob and the LP gas tank to **OFF**. Replace with a spare LP gas tank and resume burning. Store the spare LP gas tank in a well ventilated area, away from children.

Problem: Burner JUST LIGHT UP FOR SECOND AND WILL AUTOMATICALLY TURN OFF

HOW TO REPLACE THE THERMOCOUPLE ON A 30,000-50,000 BTU FIRE TABLE

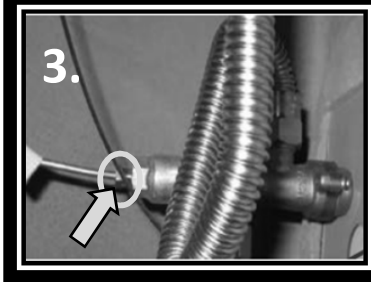

3. Inside the unit, you will notice that the end of the thermocouple line is directly screwed in to the gas valve. Please unscrew the thermocouple from the back end of the gas valve. Do not take off the valve's silver backing, only unscrew the small nut as shown above.
Once the thermocouple is unscrewed, please remove it from the top of the unit. Feed the new one through the top of the unit towards the bottom and ensure that the nuts are screwed the top and bottom to hold it in place.
4. Screw the end of the thermocouple to the back end of the gas valve with the silver backing.

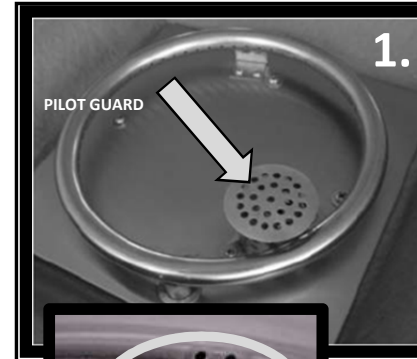

1. The thermocouple will be under the Pilot Guard on the top of the unit.
Please remove the Pilot guard by unscrewing it from the metal bowl with a screw driver.

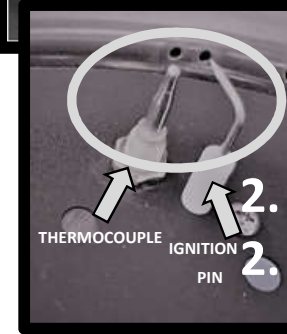

2. Once the Pilot Guard has been removed, you will have two components exposed; the copper one is your thermocouple. Please unscrew the nut holding the thermocouple in place.

Once this has been done, please test the unit.
You may have to reset the gas valve once again as the safety mechanism may have been set off by the new components introduced:

Resetting Your Gas Valve

Completely detach the propane tank from the table. Do not forget to turn the propane tank valve down. Turn the heat setting knob to high and leave it on that setting for about two to three minutes. Once you have done this, please turn the knob back to off. Hook up the propane tank and turn the propane tank's valve a quarter of a turn at a time.

NOTE: When reattaching the propane tank, please turn the valve to release the gas back in to the unit VERY SLOWLY. We want the unit to register gas coming through but not too much at once, this will flood the unit and you will have to start all over!

This is so that the gas valve can register the gas coming through a little at a time. Once you have turned the gas on all the way please go ahead and try to light the table again. This should reset your fire table's safety mechanism