



---

## USE & CARE GUIDE

---

EN



***ABSORPTION MINIBAR***

**FAB DESIGN**

---

**THANK YOU FOR YOUR TRUST AND FOR BUYING THIS APPLIANCE.**

THE FAB5 ABSORPTION MINIBAR IS FOR USE IN THE UNITED STATE OF AMERICA ONLY AND MUST BE USED FOR STORING FOODS AT THE TEMPERATURE OF 32°F AND HIGHER.

**3 - 16**

---

**NOUS VOUS REMERCIONS DE LA CONFIANCE QUE VOUS NOUS AVEZ TÉMOIGNÉE EN CHOISSANT CET APPAREIL.**

LE MINIBAR À ABSORPTION FAB5 EST À UTILISER EXCLUSIVEMENT AUX ETAS UNIT D'AMERIQUE ET IL FAUT ÊTRE UTILISÉ IMPERATIVEMENT POUR LA CONSERVATION DES ALIMENTS À UNE TEMPÉRATURE DE 32°F OU SUPÉRIEURE.

**17 - 30**

---

**GRACIAS POR SU CONFIANZA AL ADQUIRIR ESTE APARATO.**

EL MINIBAR DE ABSORCIÓN FAB5 ESTÁ DISEÑADO ÚNICAMENTE PARA SER UTILIZADO EN LOS ESTADO UNIDOS DE AMERICA Y PARA CONSERVAR ALIMENTOS A UNA TEMPERATURA DE 32°F O SUPERIOR.

**31 - 44**

Please attach the label supplied on the rear of this booklet (**if present**) to this space otherwise please complete referring to the product data plate to identify the model ("MOD") and serial number ("S/N")

Apposez ici l'étiquette autoadhésive présente au dos du livret, sinon complétez l'espace libre à l'aide des renseignements de la plaque signalétique du produit pour identifier le modèle ("MOD") et le numéro de serie ("S/N")

Pegar aquí la etiqueta adhesiva con los datos del producto, **si se encuentra en la parte posterior de este cupón**. De no ser así, completar los espacios con los datos necesarios tomando como referencia la ficha de características del producto para identificar el modelo ("MOD") y el numero de serie ("S/N")

**MOD:** \_\_\_\_\_

**S/N:** \_\_\_\_\_

1. IMPORTANT SAFETY INSTRUCTIONS.....	4
2. PROPER DISPOSAL OF YOUR REFRIGERATOR.....	5
3. INSTALLATION INSTRUCTIONS.....	6
3.1 Unpack the absorption minibar.....	6
3.2 Location requirements.....	7
3.3 Positioning and levelling the appliance.....	8
3.4 Electrical requirements.....	9
4. PRODUCT DESCRIPTION.....	10
4.1 Intended use of the absorption minibar.....	10
4.2 Shelves.....	10
4.3 Top door shelf and bottle container.....	10
4.4 Inside lighting.....	11
4.5 Air vents.....	11
5. ABSORPTION MINIBAR USE.....	12
5.1 Using the controls.....	12
5.2 Storing food.....	12
5.3 Making ice-cubes.....	12
6. ABSORPTION MINIBAR CARE.....	13
6.1 Cleaning the absorption minibar.....	13
6.2 Changing the inside light.....	13
6.3 Power interruptions.....	13
6.4 Vacation and moving care.....	14
7. TROUBLESHOOTING.....	15

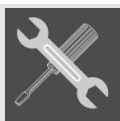

**INSTRUCTIONS FOR THE INSTALLER:** these are intended for the **qualified engineer** who is able to install, commission and test the appliance.



**INSTRUCTIONS FOR THE USER:** these provide recommendations for use, a description of the controls and the correct procedures for cleaning and maintaining the appliance.



**CONSUMER SUPPORT:** this provides useful details about warranty conditions and service information.

## 1. IMPORTANT SAFETY INSTRUCTIONS



**READ AND SAVE THESE INSTRUCTIONS** – Your Safety And the Safety of Others Are Very Important. We have provided many important safety messages throughout this manual and on your appliance. Read all instructions before using your appliance and always obey all safety messages.



### RECOGNIZE SAFETY INFORMATION

This is a safety alert symbol. This symbol alerts you to potential hazards that can kill or hurt you and others.

### UNDERSTAND SIGNAL WORDS

A signal word – DANGER, WARNING, or CAUTION – is used with the safety-alert symbol. DANGER identifies the most serious hazards. It means you can be killed or seriously injured if you do not immediately follow instructions. WARNING means you can be killed or seriously injured if you do not follow instructions. CAUTION indicates a potentially hazardous situation which, if not avoided, may result in minor or moderate injury.



### WARNING - FOR YOUR SAFETY

- Use this appliance only for its intended purpose as described in this Instruction Manual.
- Ensure proper installation in accordance with the Installation Instructions before using this appliance.
- Use two or more people to move and install refrigerator.
- Do not climb, stand or hang on the shelves in the refrigerator. This could cause serious injury or result in damage to the refrigerator.
- Never allow children to play with the refrigerator and use the drawers, shelves and others parts of the appliance only as described in this handbook.
- Never store explosive or flammable substances, such as gasoline in or in the vicinity of this refrigerator or use gasoline or other flammable vapors or liquids in the vicinity of this or any other appliance. Read product labels for warnings regarding flammability and other hazards.  
*Failure to do so can result in death, explosion or fire.*
- Use nonflammable cleaner.
- High alcohol drinks must only be stored sealed and vertical.
- Never touch frozen product straight from the freezer or put it in your mouth. This can cause burn injury due to very low temperatures.
- Unplug your refrigerator before cleaning and making repairs.
- Disconnect power before installing ice maker (on ice maker kit ready models only).

## 2. PROPER DISPOSAL OF YOUR REFRIGERATOR



### DANGER - CHILD SAFETY

- **CHILD ENTRAPMENT HAZARD:** Child entrapment and suffocation are not problems of the past. Junked or abandoned refrigeration products are still dangerous – even if they will sit for “just a few days.” If you are getting rid of your old appliance, please follow these instructions to help prevent accidents.

#### Before you throw away your old refrigerator/freezer:

- Remove doors;
  - Leave shelves in place so children may not easily climb inside;
  - Have refrigerant removed by a qualified service technician.
- Destroy or recycle the carton, plastic bags, and any exterior wrapping material immediately after the refrigerator is unpacked. Children should NEVER use these items to play. They can cause suffocation and death.
  - Do not allow children to climb, stand or hang on the shelves in the refrigerator.
  - Never allow children to play with the refrigerator.

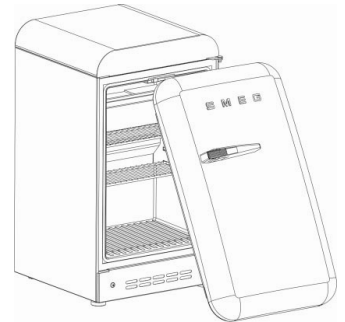

### ELECTRICAL INFORMATION

To reduce the risk of fire, electric shock, or injury to persons when using this refrigerator, follow basic precautions, including the following:

- The power cord to this appliance is equipped with a three-prong grounding plug for your protection against electrical shock hazards. It must be plugged directly into a properly grounded three-prong receptacle.
- Do not, under any circumstances, cut or remove the third (ground) prong from the power cord. For personal safety, this appliance must be properly grounded.
- Have the wall outlet and circuit checked by a qualified electrician to make sure the outlet is properly grounded.
- Do not use an adapter plug.
- Do not use an extension cord.
- Never unplug an appliance by pulling on the power cord. Always grip the plug firmly and pull straight out from the outlet to prevent damaging the power cord.
- Unplug the refrigerator before servicing.



### 3. INSTALLATION INSTRUCTIONS

#### 3.1 Unpack the absorption minibar



#### WARNING

**Excessive Weight Hazard.**

**Use two or more people to move and install refrigerator.**

**Failure to do so can result in back or other injury.**

##### 3.1.1 Remove the Packaging

- Remove tape and glue residue from surfaces before turning on the absorption minibar. Rub a small amount of liquid dish soap over the adhesive with your fingers. Wipe with warm water and dry.
- Do not use sharp instruments, rubbing alcohol, flammable fluids, or abrasive cleaners to remove tape or glue. These products can damage the surface of your absorption minibar. For more information, see “en.”
- On some models, shelves, bins, door shelf rails, and other feature parts may be packaged in the Interior FeaturePak. Follow the instructions contained in the package for proper assembly.
- Properly dispose of packaging.



##### When Moving Your absorption minibar:

- Your absorption minibar is heavy. When moving the absorption minibar for cleaning or service, be sure to protect the floor.
- Always pull the absorption minibar straight out when moving it.
- Do not wiggle or “walk” the absorption minibar when trying to move it, as floor damage could occur.

##### 3.1.2 Clean Before Using

After you remove all of the package materials, clean the inside of your absorption minibar before using it. See the cleaning instructions in “6. ABSORPTION MINIBAR CARE”.



##### Important information to know about glass shelves and covers:

Do not clean glass shelves or covers with warm water when they are cold. Shelves and covers may break if exposed to sudden temperature changes or impact, such as bumping.

For your protection, tempered glass is designed to shatter into many small, pebble-size pieces. This is normal. Glass shelves and covers are heavy. Use special care when removing them to avoid impact from dropping.



## 3.2 Location requirements



### WARNING



**Explosion Hazard.**

Keep flammable materials and vapors, such as gasoline, away from refrigerator.

Failure to do so can result in death, explosion, or fire.



**NOTE:** It is recommended that you do not install the refrigerator near an oven, radiator, or other heat source. If this is unavoidable, a suitable insulating panel must be used to allow the appliance to work properly.

- Always place the absorption minibar in a dry place with satisfactory ventilation. Never expose it to direct sunlight or install it outdoors. Depending on its climate class, the appliance can be used in different temperature conditions.
- The climate class is specified on the nameplate **which is positioned in the top left-hand corner of the body of the minibar.**
- Choose a place that is near a grounded electrical outlet. **Do not use an extension cord or an adapter plug.**
- To ensure proper ventilation for your absorption minibar, allow for a 1/2" (12.70 mm) space on each side. Allow 3" (7.5 cm) of space between overhead cabinets and minibar top. Allow at least 1" (25.40 mm) between back of cabinet and the wall. If your absorption minibar has an ice maker, make sure you leave some extra space at the back for the water line connections.
- If you are installing your absorption minibar next to a fixed wall, leave 12 1/2" (31.8 cm) minimum on the hinge side (depending on your model) to allow for the door to swing open.
- Level the absorption minibar. See "3.3 Positioning and levelling the appliance".

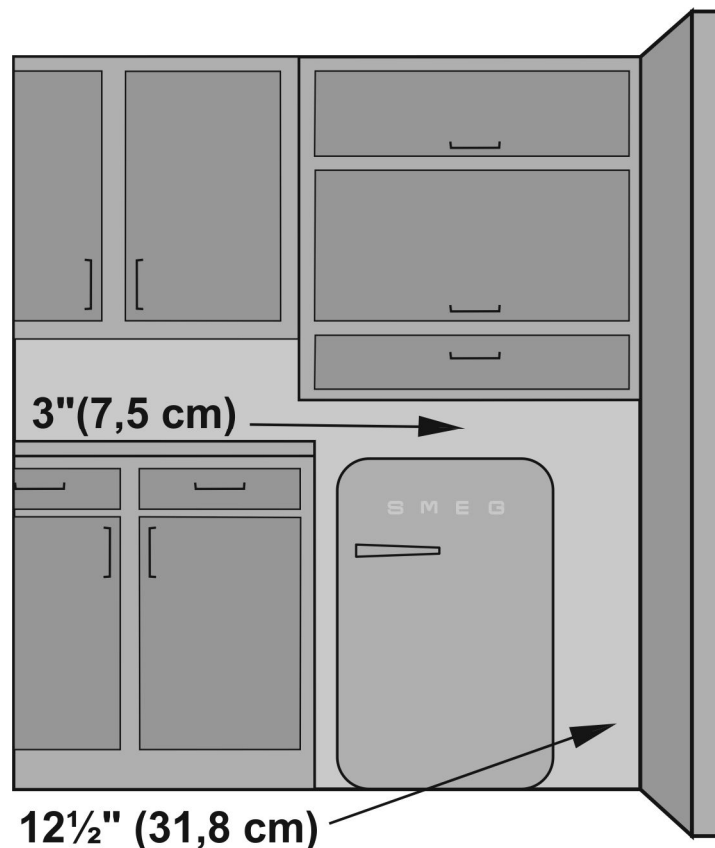



The temperature conditions are listed in the table below:

Class	Ambient temperature
SN (Subnormal)	from + 50° F to + 89° F
N (Normal)	from + 61° F to + 89° F
ST (Subtropical)	from + 64° F to + 100° F
T (Tropical)	from + 64° F to + 109° F

- The absorption minibar must be placed at least 1 1/6" from electric or gas cookers and at least 11 5/6" from combustion or radiation heating systems.
- To allow proper cooling of the condenser, the absorption minibar must not be placed too close to the wall. To prevent this, the appliance comes complete with two plastic spacers fitted at the top of the condenser. If the absorption minibar is installed underneath a wall cupboard, the distance between the two must be at least 5 cm.
- Position the absorption minibar so that the **door can be opened fully**.

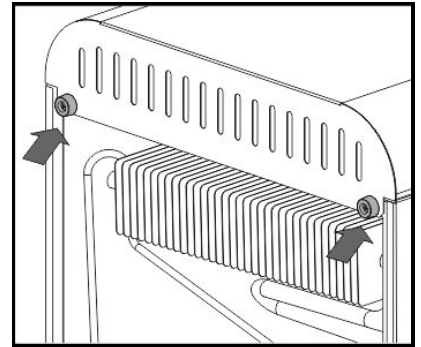

**NOTE:** Pay attention not to scratch or damage the floor when installing the appliance. If necessary, when positioning slide the absorption minibar over pieces of wood or a mat to the point decided for connection to the electrical mains.

### 3.3 Positioning and levelling the appliance

Place the absorption minibar on a **firm, level surface**. To compensate for any unevenness in the floor, the absorption minibar has four adjustable feet. This gives it added stability and makes it easier to move around and position. Take great care **when moving the appliance not to damage the floor** (for example, when installing on a parquet floor).

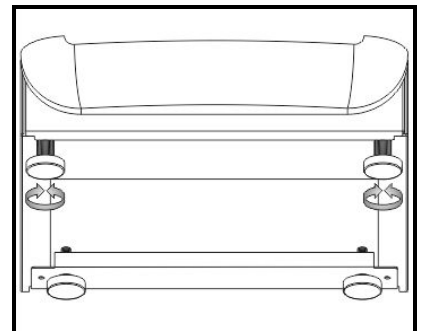





## 3.4 Electrical requirements



### WARNING



#### Electrical Shock Hazard.

Plug into a grounded 3-prong outlet.

Do not remove ground prong.

Do not use an adapter.

Do not use an extension cord.

Failure to follow these instructions can result in death, fire, or electrical shock.



**NOTE:** Before you move your absorption minibar into its final location, it is important to make sure you have the proper electrical connection.

- Before switching the absorption minibar on for the first time, leave it vertical for at least two hours. Then connect the appliance's power supply lead to a main socket with earth contact, installed in accordance with electrical safety regulations. The rated voltage and frequency are stated on the nameplate inside the minibar compartment.
- The appliance must be connected to the electrical mains and earthed in compliance with the relevant regulations and requirements. The appliance is able to withstand short fluctuations in voltage of no more than 15% less or 10% more than the rated voltage stated on the nameplate.
- If the power supply lead has to be replaced, this operation must only be carried out by an **authorised technical service engineer**.
- The socket must be accessible after the appliance has been placed.

### 3.4.1 Recommended Grounding Method

A 115 Volt, 60 Hz., AC only 15- or 20-amp fused, grounded electrical supply is required. It is recommended that a separate circuit serving only your absorption minibar be provided. Use an outlet that cannot be turned off by a switch. **Do not use an extension cord.**



**NOTE:** Before performing any type of installation or cleaning, turn the control (Thermostat, absorption minibar) on position **0** (STOP) and then disconnect the absorption minibar from the electrical source. When you are finished, reconnect the absorption minibar to the electrical source and reset the control (Thermostat, absorption minibar) to the desired setting.



## 4. PRODUCT DESCRIPTION

### 4.1 Intended use of the absorption minibar



#### WARNING

Never allow children to play with the absorption minibar and use the drawers, shelves and other parts of the appliances only as described in this handbook.

- 1 Inside light.
- 2 Ice-cube tray.
- 3 Small bottles/jars container.
- 4 Top door shelf.
- 5 Removable shelves.
- 6 Thermostat knob.
- 7 Bottle container.
- 8 Bottle shelf.

The absorption minibar has undergone the necessary tests on the tightness of the refrigeration circuit and complies with the safety regulations for electrical appliances.

To open the door, pull the handle towards you.

To close, push the door towards its hook and check that it snaps shut.

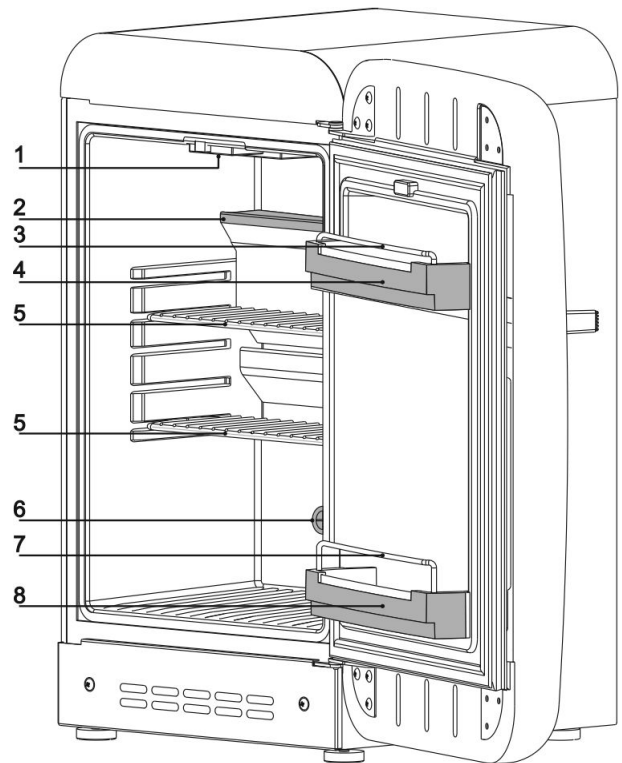

The absorption minibar **produces no noise** while running as it is not fitted with a compressor or moving mechanical parts.

### 4.2 Shelves

The absorption minibar comes complete with several shelves which can be set at different heights by placing them on the runners provided. Then change the position of the shelf or shelves as you require. For easy removal of all internal accessories, the door has to be opened completely.

### 4.3 Top door shelf and bottle container

The inside of the door is fitted with a shelf for storing tubes, small packages and jars. The bottom of the door has a shelf to take vertical bottles and cans. To stop bottles from falling when the door is opened and closed, they must be secured with the special retainer rod supplied.

The shelf and container can be removed for cleaning. To remove them from the door, tap them upward with your fist on one side of the insertion zone and then on the other.

- Do not place excessively heavy bottles on the bottle shelf;
- Place bottles on the shelf gently when loading them (pic. 1);
- When removing bottles, do not pull them in a diagonal direction as this may over-strain the retainer rod (pic. 2);
- Avoid dropping the bottles into place.



pic. 1

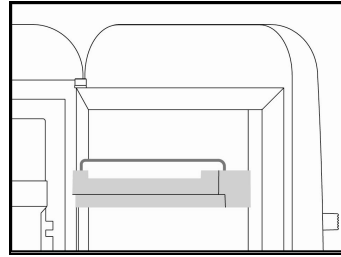
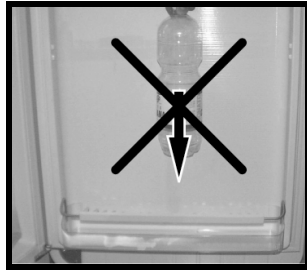

pic. 2

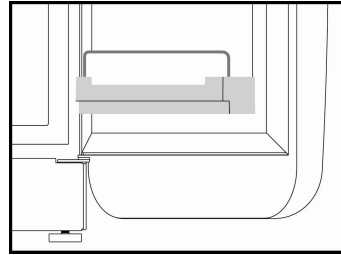
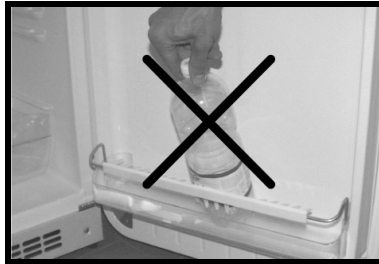

The top door shelf and the bottle shelf, as well as the bottle/jar container, are not interchangeable and **must not be inverted** after being taken out for cleaning. Otherwise, bottles may fall out when the door is opened.

#### 4.4 Inside lighting

When the minibar door is open, the light comes on; it remains on until the door is completely closed again. The light comes off if the minibar thermostat is set on **0** (STOP), meaning that the absorption minibar is switched off.

#### 4.5 Air vents

The air vents at the bottom front and top rear of the appliance **must not be obstructed in any way**; absorption minibar operation would be jeopardised.

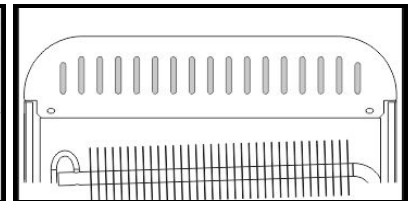
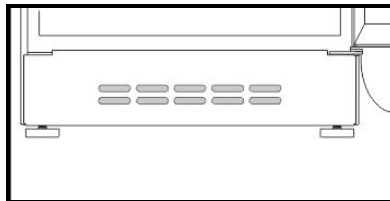

The absorption minibar **produces no noise** while running as it is not fitted with a compressor or moving mechanical parts.



## 5. ABSORPTION MINIBAR USE

### 5.1 Using the controls

The knob at the bottom of the absorption minibar is used to set the operating temperature in the minibar. When the knob is turned to **0**, the appliance is switched off. The operating settings are from **1** to **9**. There is no direct correspondence between the setting chosen and the temperature. Increasing the setting number reduces the temperature inside the appliance. In normal operating conditions, a medium-low setting (**1-5**) is recommended.

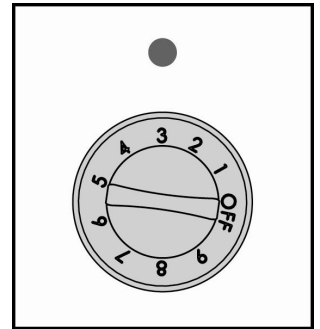

Only use the highest (coldest) settings (**8-9**) if absolutely necessary: With these settings the temperatures inside the absorption minibar may be close to 32°F, and the electricity consumption will be higher. In normal operating conditions, a normal setting (**1-5**) is recommended to provide effective storage of food in the absorption minibar.



#### NOTE:

- Changes in weather conditions (temperature and humidity) and the frequency with which the door is opened may affect the minibar's operating temperatures.
- Give your absorption minibar time to cool down completely before adding food. It is best to wait 24 hours before you put food into the absorption minibar.
- If you add food before the absorption minibar has cooled completely, your food may spoil. Adjusting the Control to a higher (colder) level might not improve the performance of the appliance.

### 5.2 Storing food



#### WARNING

**Never store explosive substances in the appliance and high-alcohol drinks must only be stored sealed and vertical.**

- Never store inflammable, volatile or explosive substances.
- Beverages with high alcohol percentage shall be stored in tightly sealed bottles in vertical position.
- Food should not touch the rear wall of the absorption minibar!
- Some organic solutions can cause damages when in contact with plastic surfaces or gaskets for longer period of time.
- Unpleasant odor inside the absorption minibar is a sign that something is wrong with foods or that your minibar needs cleaning. Unpleasant odor can be eliminated or reduced by washing the interior of the absorption minibar with a mild solution of water and vinegar. We also recommend using activated carbon filters to clean the air or to neutralize odors.
- If you plan a longer journey, make sure to remove quickly perishable articles of food out of the appliance before you leave.

### 5.3 Making ice-cubes

Recommended thermostat setting for ice making is position between **3** and **5**.

Fill the ice cube tray (two thirds of it) with cold water or with any liquid suitable for freezing and insert the tray into place. Dry the bottom of the tray to prevent freezing remains attached.

The best method to get ice cubes out of the tray is to hold the tray under cold tap water for a second, turn it around and slightly bend it.

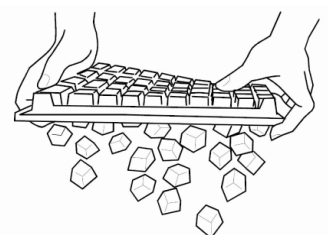



## 6. ABSORPTION MINIBAR CARE

### 6.1 Cleaning the absorption minibar



#### WARNING



**Explosion Hazard.**  
**Use nonflammable cleaner.**  
**Failure to do so can result in death, explosion, or fire.**

Clean absorption minibar about once a month to prevent odors from building up.

To clean your absorption minibar:



**NOTE:** Do not use abrasive or harsh cleaners such as window sprays, scouring cleaners, flammable fluids, celaning waxes, concentrated detergents, bleaches or cleansers containing petroleum products on plastic parts, interior and door liners or gasket. Do not use paper towels, scouring pads, or other harsh cleaning tools. Pay attention not to wet the electrical lighting components with water or other detergents.

Before cleaning, disconnect the plug from the electrical mains. Clean the outside using only water and a gentle liquid detergent or an ordinary detergent for washable surfaces (such as a window-cleaning product). Never use products containing abrasives or substances which may attack the lacquered or painted parts, acids or chemical solvents. Use a sponge or a soft cloth. Do not use steam cleaners to clean the inside; we recommend the use of specific disinfectants.

Remove the shelves and accessories, taking care not to apply excessive force when removing. Follow the instructions provided in the "Top door shelf and bottle container" section carefully. Never wash removable plastic parts in the dishwasher; use only warm water and washing-up liquid or water and vinegar. Take care not to wet the electrical lighting components with water or detergents. Clean the seals with warm water and then dry.

To allow the absorption minibar to operate at full efficiency, periodically also clean the condenser on the rear with a brush or a vacuum cleaner.

Also make a periodic check on the condensation drip tray at the rear, and clean it if necessary.

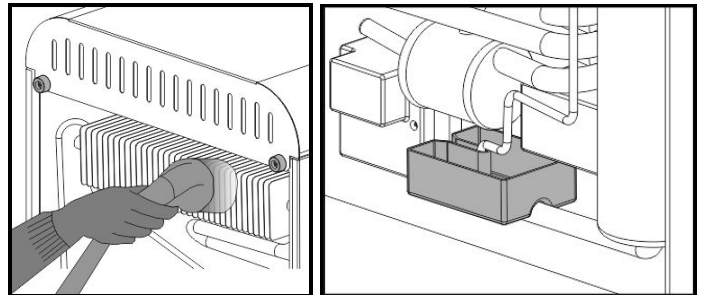

### 6.2 Changing the inside light

If the inside light does not work, make sure that the voltage is present and that the plug of the power cord is inserted correctly. If the problem persists, contact After-Sales Service.

### 6.3 Power interruptions

If the power will be out for 24 hours or less, keep the door or doors closed (depending on your model) to help food stay cold.



## **6.4 Vacation and moving care**

### **6.4.1 Vacations**

If you choose to leave the absorption minibar on while you're away, use up any perishable and freezer other items. Alternatively, you can choose to turn the absorption minibar off before you leave, and follow these steps:

- 1 Remove all food from the absorption minibar.
- 2 Turn the control knob to **0** (STOP).
- 3 Clean the absorption minibar, wipe it and dry it well.
- 4 Tape rubber or wood blocks to the top of the door to prop it open far enough for air to get in. This stops odor and mold from building up.

### **6.4.2 Moving**

When you are moving your absorption minibar to a new home, follow these steps to prepare it for the move:

- 1 Remove all food from the absorption minibar and pack all frozen food in dry ice.
- 2 Empty the ice bin.
- 3 Turn the control knob to **0** (STOP).
- 4 Unplug the absorption minibar.
- 5 Empty water from the defrost pan.
- 6 Clean, wipe and dry thoroughly.
- 7 Take out all removable parts, wrap them well and tape them together so they don't shift and rattle during the move.



## 7. TROUBLESHOOTING

Try the solutions suggested here first in order to avoid the cost of an unnecessary service call.

	<b>WARNING</b>	<p><b>Electrical Shock Hazard.</b>  <b>Plug into a grounded 3-prong outlet.</b>  <b>Do not remove ground prong.</b>  <b>Do not use an adapter.</b>  <b>Do not use an extension cord.</b>  <b>Failure to follow these instructions can result in death, fire, or electrical shock.</b></p>
--	----------------	---

PROBLEM	POSSIBLE CAUSE	PROBABLE SOLUTION
The absorption minibar does not start up:	<ul style="list-style-type: none"> <li>- temperature regulator on 0 (stop).</li> <li>- power supply lead not connected to the electrical mains;</li> <li>- mains socket not supplying electrical power.</li> </ul>	<ul style="list-style-type: none"> <li>- connect the lead to the power supply;</li> <li>- contact the electricity supplier.</li> </ul>
Minibar section not cooled sufficiently:	<ul style="list-style-type: none"> <li>- inside temperature setting thermostat set too low (1-2) (this corresponds to higher minibar temperature);</li> <li>- door opened often or for long periods;</li> <li>- door not closing properly;</li> <li>- rise in outside temperature.</li> </ul>	<ul style="list-style-type: none"> <li>- turn the regulator to an intermediate setting (3-4);</li> <li>- open the door less often and for as short a time as possible;</li> <li>- check that the foods are arranged on the shelves correctly and are not preventing the door from closing properly, and that the absorption minibar is well levelled on the floor;</li> <li>- check that the gasket is sealing properly and is not damaged.</li> </ul>
Door hard to open just after closing:		<ul style="list-style-type: none"> <li>- if you attempt to open the door again just after closing it, considerable strength is required. This is because of the vacuum caused by cooling of the warm air that has entered the appliance.</li> </ul>
Too much condensation forming in minibar section:	<ul style="list-style-type: none"> <li>- check that the door gaskets are providing an airtight seal on the absorption minibar;</li> <li>- door opened often or for long periods.</li> </ul>	<ul style="list-style-type: none"> <li>- in case of cracks, try to soften the gasket by pulling it with one hand and sliding your closed fingers along the inside;</li> <li>- open the door less often and for shorter times, especially when the appliance is working in warm, humid conditions.</li> </ul>
Temperature inside minibar section too cold:	<ul style="list-style-type: none"> <li>- cooling temperature regulator device set too high (meaning lower temperature).</li> </ul>	<ul style="list-style-type: none"> <li>- turn the regulator to a lower setting (1-2).</li> </ul>



PROBLEM	POSSIBLE CAUSE	PROBABLE SOLUTION
Too much ice forming on back wall of minibar section (layer of frost more than 3/8" - 1 cm thick):	<ul style="list-style-type: none"> <li>- cooling temperature regulator device set too high (meaning lower temperature inside the appliance);</li> <li>- door opened often or for long periods.</li> </ul>	<ul style="list-style-type: none"> <li>- turn the regulator to a lower setting (1-2) to increase the temperature inside the appliance slightly;</li> <li>- check that the gaskets are providing an airtight seal;</li> <li>- open the door less often and for shorter times;</li> <li>- rise in atmospheric temperature and humidity;</li> <li>- do not place hot food or drinks inside the absorption minibar.</li> </ul>
Front of cabinet hot to the touch:		<ul style="list-style-type: none"> <li>- the absorption minibar is operating normally. Inside the cabinet there is a surface cooling system designed to restrict the formation of condensation in the area where the door gasket closes.</li> </ul>

#### **AFTER-SALES SERVICE – READING THE NAMEPLATE.**

IF THE PROBLEMS WITH THE PRODUCT YOU HAVE PURCHASED ARE NOT AMONGST THOSE DESCRIBED ABOVE AND IF YOU NEED MORE INFORMATION, PLEASE CONTACT THE AUTHORISED AFTER-SALES SERVICE. YOU WILL FIND THE ADDRESS AND TELEPHONE IN YOUR LOCAL TELEPHONE DIRECTORY UNDER **SMEG**.

TO SPEED UP THE SERVICE, PLEASE BE READY TO INFORM OUR CALL SERVICE OPERATORS OF THE MODEL OF THE PRODUCT YOU HAVE PURCHASED AND THE SERIAL NUMBER MARKED ON THE NAMEPLATE INSIDE THE BODY OF THE REFRIGERATOR. THANK YOU IN ADVANCE FOR YOUR ASSISTANCE.



The manufacturer reserves the right to make any changes deemed useful for improvement of his products without prior notice. The illustrations and descriptions contained in this manual are therefore not binding and are merely indicative.

Le constructeur se réserve la faculté d'apporter, sans préavis, toutes les modifications qu'il jugera utiles pour l'amélioration de ses produits. Les illustrations et les descriptions figurant dans ce manuel ne sont pas contraignantes et n'ont qu'une valeur indicative.

El fabricante se reserva el derecho a aportar sin aviso previo todas las modificaciones que considere útiles para la mejora de sus propios productos. Las ilustraciones y las descripciones contenidas en este manual no comprometen, por tanto, al fabricante y tienen un valor meramente indicativo.

